



Col. David Hackworth: "Lap Dogs" Leading the U.S. Military

SOLDIER OF FORTUNE

FAST-ROPE INTO HELL!

Untold Story of Spectacular Ranger Rescue Op in Somalia

Charlie Selling Spoils of Vietnam War

MEXICO: Newest Frontier for Hired Guns

Jailhouse Interviews with Branch Davidians

Russia's Secret Weapons Revealed!

SOLDIER OF FORTUNE

JULY 1994

JULY 1994 48493



CAN. \$4.75 • UK £2.60 • U.S. \$3.95

SOLDIER OF FORTUNE MAGAZINE

**ACTION,
ADVENTURE &
ACCURACY —
ALL AT ONE
LOW PRICE!**

- 1 yr Subscription \$24.95
- 2 yr Subscription \$47.90
- Payment Enclosed (U.S. Funds only)
- MasterCard Visa
- Exp. Date _____



Card# _____

Signature _____

NAME _____

ADDRESS _____

CITY _____ STATE _____ ZIP _____

DAY PHONE () _____

BNW 794

• Payment must accompany order. Offer good in the U.S. and possessions including APO, FPO addresses, for a limited time only. Canada add \$10.00 per year, (includes GST #R128476249) foreign add \$21.00/yr. Allow 6-8 weeks for delivery of first issue.

COL. BROWN'S IRONCLAD GUARANTEE

If for any reason you're dissatisfied, cancel your subscription, and we'll refund the unused balance, no questions asked, period.



• M I L I T A R Y S P E C •

NIGHT VISION

Lowest Prices in the United States from \$249

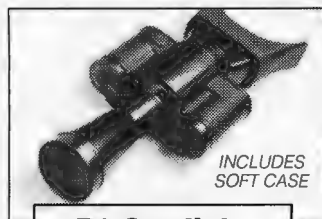

INCLUDES
SOFT CASE

B6 Starlight
GEN II PANORAMIC VIEWER

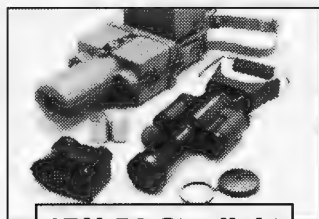

1PN-50 Starlight
GEN II A+ MILITARY



B7 Starlight
GEN II CAMERA READY

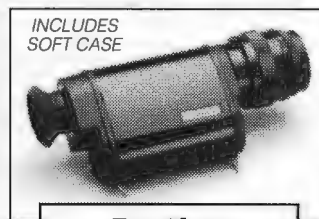

INCLUDES
SOFT CASE

Panther
POLICE MODEL w/ IR BEAM



INCLUDES
SOFT CASE

B12 Starlight
2.5x INTERACTIVE ICT



INCLUDES
HARD CASE

BN-453 Starlight
3.2x INTERACTIVE ICT



B-336 Starlight
3.2x ICT A+ MILITARY

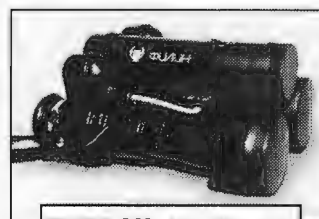

PNV Night Hawk
2.5x INTERACTIVE ICT



INCLUDES
HARD CASE

B-5P Starlight
GEN II RIFLE SCOPE

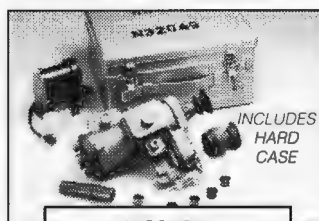

INCLUDES
HARD CASE

PN-51
GEN II 4x RIFLE SCOPE

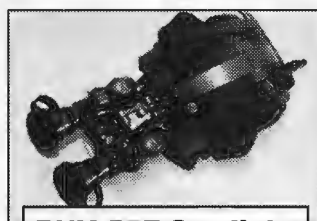

PNV-57E Starlight
LONG DISTANCE GOGGLES



B-20 Starlight
MACRO FOCUS



- Full 1-year factory warranty—ALL PRODUCTS
- 1ST 2ND & 3RD Generation Night Vision products
- FREE catalog of these and many other models
- Night Vision models as low as \$249!
- Call for our monthly special offers
- Largest U.S. supplier of Night Vision and other specialized optical devices
- Finest single source of daytime & Night Vision products for every application
- Rental and Leasing Available
- Major Credit Cards Accepted

U.S. General Technologies, Inc.

145 Mitchell Avenue • South San Francisco, CA 94080

Orders: 800-445-3300 • Information: 415-634-8440 • 24-Hour Fax: 415-634-8452

EXPOSING FAKE VETS

by Robert K. Brown

MAGAZINE STAFF

Editor/Publisher Robert K. Brown
Associate Publisher T. (Lefty) Wilson
Executive Editor Tom Slizewski
Senior Editor Don McLean
Technical Editor Peter G. Kokalis
Feature Editor Dwight Swift
Assistant Editor Lynne Robertson
Production Director Kathleen Allard
Art Director ... Mary Scrimgeour Jenkins
Assistant Art Director Kristine Anderson

Foreign Correspondents

Chief Foreign Correspondent Dr. Tom Marks
Senior Foreign Correspondents:
Steve Salisbury • Rob Krott • Peter Douglas •
Chuck Fremont • Morgan Tanner •
Jack Thompson • Maj. Mike Williams •
Mike Winchester • Dale B. Cooper

Contributing Editors

Vietnam Veterans Affairs Col. Chuck Allen •
Military History William Brooks — William H. Northacker • *Unconventional Operations* Brig. Gen. Heine Aderholt — James P. Monaghan — Maj. Robert MacKenzie • *Military Affairs* Alexander McColl • *Paramedic Operations* Dr. John Peters • *Explosives/Demolitions* John Donovan • *Aviation* Dana Drenkowski • *Africa* Al Venter • *Outdoor Affairs* Galen Geer • *Latin America* Hugo Hartenstein • *Gun Rights* Paul Danish • *Skydiving* Kitty Baran

Financial Director Gregg Peterson
Business Manager Sharon Windsor
Bookkeeper/
Classified Advertising .. Carole Hayden
Circulation Manager Carrie Karlson
Consultant Zada Johnson
Advertising Manager/Assistant
Convention Director Dianne McLeod
Receptionist Helena Oberg

For editorial/advertising, call 303-449-3750.
Subscription inquiries, call 1-800-877-5207.
For list rental contact: Dave Power, Antigone Associates 215-357-9267.

In Memoriam

Craig Nunn — Art Director
Lance Motley — Foreign Correspondent
Barry Sadler — Contributing Editor

NOTICE: SOLDIER OF FORTUNE Magazine is a magazine of national and international distribution. There may be products in the magazine of which sale, possession or interstate transportation may be restricted, prohibited or subject to special licensing requirements in your state. Purchasers should consult local law enforcement authorities in their area. All data in this publication, technical or otherwise, is based upon personal experience or individuals using specific tools, products, equipment and components under particular conditions and circumstances, some of which may not be reported in the article and which Soldier Of Fortune has not otherwise verified. Soldier Of Fortune, its agents, officers and employees disclaim any responsibility for all liability, injuries or damages.

I'm fed up — up to the eyeballs — with individuals who use phony war records for self aggrandizement, economic gain or any other sick reason, particularly those dorks who show up whenever TV cameras are present, wearing faded cammies, sporting scraggly beards, long hair and five Purple Hearts — but have never left the United States.

As Colonel Fred Caristo (U.S. Army, Retired), a five-tour 'Nam vet who won the Distinguished Service Cross, points out: "These frauds belittle the KIA who only got one Purple Heart, a body bag and their name on the Wall." Also, by playing to the stereotype of the Vietnam veteran as a whacked-out pitiable victim, they reinforce the false image the left-wing media and propaganda machine has been working for years to create. And not a few of these types have parlayed their phony war records, by way of veterans' preferences in civil service selections and otherwise, into well-paid positions of undeserved public trust.

An article in the May 1994 *Reader's Digest* by Malcolm McConnell describes the efforts of B. G. Burkett, of Dallas, Texas, to expose some of these frauds. Burkett served as a lieutenant in Vietnam, got out of the Army in 1969 and used his GI Bill benefits to earn an MBA degree and become a successful stockbroker. Like the vast majority of Vietnam veterans, he is a well-adjusted, productive, tax-paying member of the middle class.

Frauds thus far exposed by Burkett include two presidents of chapters of the Vietnam Veterans of America (VVA) and several individuals supposedly so traumatized by their Vietnam experiences

that they had taken refuge in the wilderness of Washington state, where one vet obligingly howled at the moon during an interview with Dan Rather of CBS.

Burkett has also documented facts demonstrating that the Vietnam veteran is simply *not* the "loser" the left-wing has painted him to be. Respectable studies show that Vietnam veterans have one of the lowest suicide rates in America, significantly lower than their non-veteran contemporaries. Of the more than 2.5 million Americans who actually served in

Vietnam, only about 45,000 — less than 2% — have received compensation for symptoms of the highly publicized Post Traumatic Shock Disorder (PTSD) and less than 10,000 — less than four-tenths of 1% — are severely disabled. The other 98% to 99.6% are OK. Labor Department statistics show Vietnam veterans with better incomes and higher employment levels than non-veterans or the national average. Likewise, Vietnam veterans show very low rates of criminality and incarceration. And so on.

Of course the 95% to 98% who are holding down responsible jobs, raising and educating families, paying their debts and taxes, and so on, don't make good visuals for the evening news, and provide little comfort for the left-wing slime who, 22 years ago, finked out on their civic duty. So the 1% to 2% who do have problems and, even worse, the phonies who play up to the stereotype, get the coverage.

SOF is forming a non-profit organization whose sole purpose will be to investigate and expose the slimebags who pose as Vietnam veterans, but weren't there. Stay tuned. ✕



SOLDIER OF FORTUNE (USPS 525-810, ISSN 0145-6784) is published monthly by SOLDIER OF FORTUNE Inc., 5735 Arapahoe Ave., Boulder CO 80303-1340. Second-Class Postage is paid at Boulder CO and additional mailing offices. POSTMASTER: Send address changes to SOLDIER OF FORTUNE, Subscription Department, POB 348, MT Morris IL 61054-0348 or call 1-800-877-5207. U.S. and APO-FPO subscription rate for twelve monthly issues: \$28.00. Canada add \$10.00/yr. additional postage (includes GST tax registration number: R128476249). All other countries add \$21.00 U.S. FUNDS ONLY. Single Issue Price — U.S., \$3.95; United Kingdom, £2.60; Canada, \$4.75. PRINTED IN THE U.S.A.

CONTRIBUTORS: Manuscripts, photographs or drawings are submitted at the contributor's own risk. Material should be mailed to Articles Editor, SOLDIER OF FORTUNE, P.O. Box 693, Boulder, CO 80306, and cannot be returned unless accompanied by sufficient postage. Any material accepted is subject to such revision as is necessary to meet the editorial requirements of SOF. All manuscripts must be typed double-spaced. All photographs should be credited and be accurately identified. Payment will be made at rates current at time of publication. Editorial office phone number is 303-449-3750.

Copyright © 1994 by SOLDIER OF FORTUNE Magazine Inc. All Rights Reserved.

FEATURES



Ranch Security — page 57

Photo: AP/Wide World

SALUTE TO D-DAY VETS Fifty years ago, on 6 June 1944, Allied forces flooded onto the shores of Normandy in the largest amphibious operation in history. SOF takes this occasion to offer our thanks **31**

LAP DOGS LEAD THE WAY? Col. David Hackworth
U.S. military promoting "ticket-punching horse holders" to flag rank, while tactically proficient war-fighters are passed over or forced out **32**

LOVABLE, YET LETHAL Peter G. Kokalis
Scattergun Technologies and frequent SOF contributor Louis Awerbuck combine to produce a "politically correct" combat 12-gauge that looks like a goose gun but features all the right stuff for self-defense **36**

FAST-ROPE INTO HELL Dale B. Cooper
Dropping blindly into the chaos of a running firefight, Air Force PJs and Army Rangers battle their way to the site of a downed Blackhawk helicopter and stand fast for 15 hours against overwhelming odds **40**

"WE HAVE THE TRUTH ON OUR SIDE" James L. Pate
Branch Davidians — now homeless and stripped of all possessions — put their faith in God even after being victims of the biggest disaster in law enforcement history **46**



Salute To D-Day Vets — page 31

Photo: AP/Wide World



COLUMNS



Bulletin Board 6
Gun Grabbers' Dream Come True

Slick Willie Watch 10
Clinton Death Clock

I Was There 14
The Old Man And The Tea (House)

World SitRep 16

Combat Weaponcraft 19
Reaction Reflex

FLAK 24

Supply Locker 72

Advertisers Index 76

Classified 77

Parting Shot 82
Fields Of Normandy

Lap Dogs Lead Way — page 32

Photo: SOLO

RUSSIA'S SECRET WEAPONS SOF Staff
 Need for hard currency has Russia selling its latest developments in advanced specops weaponry. Several new designs show surprising innovation 50

NEXT FRONTIER FOR HIRED GUNS Dr. Tom Marks
 Crime and corruption are a growth industry in Mexico where recent bombings, kidnappings and the Zapatista uprising have fueled a cry for skilled, armed professionals 54

RANCH SECURITY — MEXICAN STYLE Douglass Norvell
 Cattle ranchers stand up to Zapatista rebels-turned-rustlers in rural Mexico's "no-fire" zones where the only law comes from the barrel of a gun 57

CHARLIE SELLS CHOPPERS Will Cadence
 Hanoi is hustling the spoils of war America left behind in 1975: Chopper engines, airframes of all types and even high-tech weaponry are plentiful — and cheap 58

COVER

U.S. Marine Corps corporal stands guard atop prison in Mogadishu, Somalia — where Aidid and his henchmen should be spending all their free time after shooting down two American helicopters and engaging in 15-hour firefight with U.S. troops. Related article on page 40. Photo: AP/Wide World

BULLETIN BOARD

GUN GRABBERS' DREAM COME TRUE

While we write this, under auspices of the Defense Logistics Agency, the Anniston (Alabama)



Reader Lt. Marco Ruggiero of Italy's *UNUCI Firenze* patrol takes a moment before a mountain patrol tournament near Rome to pose with his colleagues and *SOF*. Marco expressed hope we could publish the picture before lawyers run us out of business. Glad to! And lieutenant, feel free to send us a picture of your son in uniform when he grows up and we'll print that, too. *SOF* will be right here, doing what we do best. Photo: courtesy of *UNUCI Firenze*

Army Depot is destroying (are you ready for this?):

- 110,000 M1911A1 .45 pistols
 - 45,000 .30 M1 carbines
 - 40,000 M1903A3 Springfield drill rifles
 - 30,000 M1 Garand rifles
 - 6,000 M1903A3 Springfield infantry rifles
 - 6,000 M2 .22 Springfield rifles
- Nossir, can't give those nasty assault .22s to DCM clubs, or the big bore stuff to a worthy ally. Better cut 'em up.*

In a related development, the U.S. Army Munitions and Chemical Command has let a contract for \$3.4 million to Olin Corp. for the demilitarization of other small arms.

CAESAR DON'T ALLOW ...

Proposed new rules for public land administered by the national [Socialist] forest system: *no hunting, trapping, fishing, catching, killing any kind of wild animal, bird,*

fish, shellfish, or taking eggs of any bird or fish. Also to be made illegal: possession of any "device capable of causing injury to persons or wildlife" [leave your tire irons at the gate?]; removing any mineral or mineral material [wipe your shoes when you leave?]; any obscene language or gestures [boy, are we tempted!].

The public comment period has been extended. Send written comments to F. Dale Robertson, Chief (5300), Forest Service USDA, Box 69090, Washington, D.C. 20090-6090. If you write, be direct and be polite — remember, no obscene language or gestures.

RUSSIAN POWER PLAY

Civil utility authorities in Baltiysk, Russia, cut electricity to the Russian

Baltic Fleet HQ after the Ministry of Defense failed to pay a 500,000,000 ruble (\$320,000) power bill. A week later, payment restored power. *Heh, heh.* We have to sort of sympathize: been there, done that.

GUN RIGHTS READING

Things You Can Do To Defend Your Gun Rights — a new political action manual by Allan M. Gottlieb and Dave Kopel, 177 powerful pages, \$9.95 from: Merril Press, Dept. SOF, Box 1682, Bellevue, WA 98008.

Guns, Murders, and the Constitution: A Realistic Assessment of Gun Control — dynamite material by Don B. Kates from: Pacific Research Institute for Public Policy, Dept. SOF, 177 Post St., San Francisco, CA 94108.

Concealed Carry Permits and Children and Guns, both by Dave Kopel and available from:

Independence Institute, Dept. SOF, 14142 Denver W. Parkway, Suite 101, Golden, CO 80401-3134.

Myths About Gun Control, by Morgan O. Reynolds and W. W. Caruth III, available from: National Center for Policy Analysis, Dept. SOF, 12655 N. Central Expressway, Suite 720, Dallas, TX 75243.

"Assault Weapons" Revisited — An Analysis of the AMA Report, Guns in the Medical Literature — A Failure of Peer Review, and The Right to Keep and Bear Arms — A Primer for Physicians. Three monographs by Dr. Edgar A. Suter, Chair, Doctors for Integrity in Research and Public Policy (Dept. SOF, 5201 Norris Canyon Road, Suite 140, San Ramon, CA 94583; phone: 510-277-0333; fax: 510-277-1283). Hard science, well-documented: Good ammo when debating those who would dazzle the audience with pseudo-science and other forms of high-sounding BS; \$10 each or all three for \$25.



Friend of *SOF* Gene DeSantis (of DeSantis holsters) poses deep beneath the streets of Moscow with a new 9mm Makarov caliber submachine gun being offered for sale. Lots of goodies are now on international market since Ivan has decided to compete with commercial western arms makers. See related story on page 50. Photo: courtesy Gene DeSantis



PRO SNIPER

An Inside Look at Today's Top Military and Police Snipers

Whether it's a tense hostage situation in an American city or an enemy leader who needs to be terminated in a war zone, police and military snipers are called upon as the ultimate force in modern tactical operations. **Pro Sniper** takes you inside the special world of these elite officers and soldiers. You'll receive training, deployment and marksmanship tips from SEAL, SWAT and other top snipers. You'll walk through the unique missions of police and military snipers while experts highlight the vital differences between each. You'll get a guided tour of the SEAL armory and its special .50-caliber sniper rifles, remarkable night-vision optics and state-of-the-art field communications gear. Finally, you'll get a behind-the-scenes look at a little-known modern sniper competition, pitting the world's best sniper teams against each other in a test of their skills under physically and mentally stressful conditions. **Pro Sniper** includes extraordinary footage of SEAL snipers covering teammates during an actual ship boarding, SWAT snipers handling weapon malfunctions during tactical situations and much more. Color, approx. 30 min., VHS only.

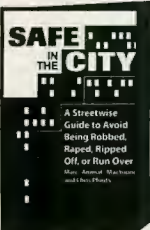

SAFE IN THE CITY
A Streetwise Guide to Avoid Being Robbed, Raped, Ripped Off, or Run Over
by Marc "Animal" MacYoung and Chris Pfouts

This is an entertaining street-level look at how crimes are really committed in America's cities. Chris and Animal use their NY-L.A. experience to help you learn the games carjackers, muggers, "gangstas," rapists, junkies and commen play—and how to avoid them. 5 1/2 x 8 1/2, softcover, 320 pp \$21.95



THE PATTERN-WELDED BLADE
Artistry in Iron
by Jim Hrisoulas

Pattern-welded blades are among the most beautiful and durable creations to emerge from the bladesmith's forge. Now, Jim Hrisoulas, author of **The Complete Bladesmith**, reveals the secrets of this ancient craft, from the welding of the starting billet to final assembly of the completed blade. Learn basic patterns and stunning, complex designs. 8 1/2 x 11, hardcover, photos, illus., 120 pp. \$35.00



CARLOS HATHCOCK: MARINE SNIPER
War Stories and Tactical Tips from the Master Sniper
w/ Carlos Hathcock & John Plaster

The most accomplished sniper of the Vietnam War and the founder of the U.S.M.C. sniper school tells in his own words how snipers outthink and outshoot their prey. In this entertaining and informative video, Hathcock talks about observation, target selection, shot placement and much more. Color, approx. 55 min., VHS only. \$29.95



USING OFFSHORE HAVENS FOR PRIVACY AND PROFITS
by Adam Starchild

In the U.S. our lives have become transparent to nosy, greedy government agencies. That's why there is a growing flight of U.S. capital abroad, to safer, more inflationproof, investment-friendly countries. Using layman's terms, Adam Starchild walks you through the reasons to invest overseas, ways to do it and where to entrust your money. 5 1/2 x 8 1/2, softcover, 160 pp.. \$15.00



THE GREEN BERETS
The Real Story Behind the U.S. Special Forces

Here is the *reality* behind the legend from Special Forces vet and best-selling author Jim Morris. Three generations of this brotherhood of highly trained, dedicated and motivated elite soldiers present a captivating oral history of their operations. Rare footage of their daring missions deep in enemy territory provides the colorful backdrop. Color, approx. 50 min., VHS only. \$29.95



THE ULTIMATE SNIPER
An Advanced Training Manual for Military and Police Snipers
by Maj. John L. Plaster, USAR (Ret.)

This highly readable and extremely valuable training book covers the practical, field-tested details of sniping's three great skill areas — marksmanship, fieldcraft and tactics. Rifles, scopes, ballistics, target detection, stalking, hides, camo, countersniping, special ops, police vs. military and much more. 8 1/2 x 11, softcover, photos, illus. 464 pp. \$39.95



GET EVEN
The Complete Book of Dirty Tricks
by George Hayduke

A hilarious overview of the methods people use to get even with big business, government and enemies. These dirty tricks range from the simple to the elaborate, including more sophisticated schemes devised by CIA and Mafia members and political dirty tricksters. *For entertainment only.* 5 1/2 x 8 1/2, hardcover, 208 pp. \$19.95



SEAL SNIPER TRAINING PROGRAM

This highly sought manual — until now available only to this elite cadre of specially trained SEALs — contains the complete program by which SEAL snipers train, equip and operate. Included are precise instructions and exclusive, clear photos for target sighting, aiming, trigger control, aircraft takeover, range estimation, helo insertion, ship boarding, stalking, marksmanship and more. 8 1/2 x 11, softcover, photos, illus. 320 pp. \$30.00



SURVIVAL AT SEA
by R.P. Brandt

This guide, the first and only one inspired by the military's survival training, is the most comprehensive sea survival manual ever made available to civilians. It covers every detail imaginable, from prior preparation to the right time to abandon ship — and if you should — to navigating your way to rescue or landfall . . . all you'll need to ensure that you reach land alive. 5 1/2 x 8 1/2, softcover, illus., 184 pp. \$15.95



ULTIMATE SNIPER: THE VIDEO
w/ John Plaster & Carlos Hathcock

Learn the art of sniping from two masters. Maj. John Plaster instructs you in all areas of sniping fieldcraft, marksmanship and tactics, and famed USMC sniper Carlos Hathcock recounts some of the field-tested tactics he used to rack up 93 confirmed kills in Vietnam. Covers optics, weapons, shooting drills, camo, stalking, hides, countersniping, range and wind estimation and more. Color, approx. 90 min., VHS only. \$59.95

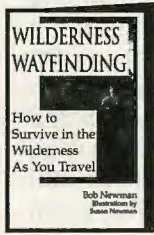

WILDERNESS WAYFINDING
How to Survive in the Wilderness As You Travel
by Bob Newman

The first truly complete easy-to-follow guide to finding your way in the forest, mountains, desert or any wild environment. Let a pro teach you about maps and compasses, land navigation, building emergency shelter, finding food and water, forecasting weather, administering first aid and much more. 5 1/2 x 8 1/2, softcover, photos, illus., 160 pp. \$15.00



HOW TO GET ANYTHING ON ANYBODY
by Lee Lapin

Get the goods on others with this encyclopedia of advanced investigative and surveillance techniques. Here are expert ways to secretly bug any target! Info on lock-pick technology, how polygraphs and voice lie detectors can be tricked and much more, including more than 100 sources for spy equipment. 8 1/2 x 11, softcover, illus., 272 pp. \$30.00

OTHER FASCINATING TITLES

- | | |
|--|---|
| PRIVACY: HOW TO GET IT. HOW TO ENJOY IT..... | CREDIT SECRETS: HOW TO ERASE BAD CREDIT..... |
| \$18.95 | \$14.00 |
| MODERN TECHNIQUE OF THE PISTOL..... | AMBUSH! NAVY SEALS IN DEADLY ACTION (VIDEO).... |
| \$45.00 | \$29.95 |
| SEAL COMBAT BOARDING MANUAL..... | HANDGUN MUZZLE FLASH TESTS: HOW POLICE CARTRIDGES COMPARE..... |
| \$20.00 | \$20.00 |
| A BOUNCER'S GUIDE TO BARROOM BRAWLING..... | WINNING A STREET KNIFE FIGHT (VIDEO)..... |
| \$17.95 | \$29.95 |
| GET EVEN 2: MORE DIRTY TRICKS FROM THE MASTER OF REVENGE..... | BATTLE BLADES..... |
| \$19.95 | \$30.00 |
| JUST SAY NO TO DRUG TESTS..... | HOW TO BEAT THE CREDIT BUREAUS..... |
| \$12.00 | \$12.00 |
| MAKING YOUR AR-15 INTO A LEGAL PISTOL..... | KGB ALPHA TEAM TRAINING MANUAL..... |
| \$14.00 | \$20.00 |
| | HARDCORE HAYDUKE..... |
| | \$19.95 |

MONEY-BACK GUARANTEE — DEALER INQUIRIES INVITED
Paladin Press • P.O. Box 1307 • Boulder, CO 80306 • (303)443-7250
FAX (303)442-8741

Videotapes are nonreturnable. Damaged tapes will be replaced.



PALADIN PRESS
P.O. BOX 1307-4GS
BOULDER, CO 80306



CREDIT CARD ORDERS CALL TOLL FREE 1-800-835-2246, ext. 21

Call 24 hours a day, 7 days a week. Send \$2.00 for a 64-page CATALOG of over 600 titles (free with order).

PLEASE SEND ME THE FOLLOWING TITLES:

RESPONSE CODE: 4GS

| | |
|-----------------------------------|--|
| <input type="checkbox"/> VISA | <input type="checkbox"/> MASTERCARD |
| <input type="checkbox"/> DISCOVER | <input type="checkbox"/> CHECK / MONEY ORDER |
| CARD# _____ | _____ |
| EXP. _____ | _____ |
| NAME _____ | SUBTOTAL _____ |
| ADDRESS _____ | PLEASE INCLUDE POSTAGE & HANDLING \$ 4.00 |
| CITY _____ | TOTAL _____ |
| STATE _____ | ZIP _____ |

PETITION TOKYO

The North Texas Arms Rights Coalition (P.O. Box 28185, Dallas, TX 75228; phone: 214-647-6486) is circulating a petition to the people of Japan, as counterpoint to the petition from Japanese individuals handed to President Clinton asking Americans to give up their guns. This petition is fundamentally different, however, in that it invites the Japanese to leave our Constitution alone, and consider adopting a Bill of Rights such as we enjoy.

Contact the Coalition directly for a copy of the petition to circulate.

MUSLIM VOLUNTEERS

Several thousand young Muslims from Indonesia, home of the world's largest Muslim population, have volunteered to fight alongside fellow Muslims in Bosnia. In one rally sponsored by the Indonesian Committee for World Muslim Solidarity, they were admonished to "be good Muslims or die as *Syuhada* [martyrs] for Bosnian Muslims ..." The Organization of the Islamic Conference (OIC) has offered to send 10,000 troops from Malaysia, Jordan, Pakistan and Egypt to join U.N. peacekeepers in Bosnia-Herzegovina. Muslim groups in Indonesia last year called for the government to send troops to Bosnia, and thousands volunteered for such a force, but Indonesian armed forces commander General Feisal Tanjung said that Indonesia lacked resources to fund such an operation.

TRYING NEW RIFLES ON FOR THAIS

The Royal Thai army ordnance department in Lopburi is quietly shopping for 60,000 replacements for their M16-M16A1s and license-built HK-33s. Although a dozen arms-makers are in the running,

insiders report the realistic short-list comprises the Steyr AUG and Israeli Galil. Colt appears reluctant to license local manufacture, and the Thais are not too enthused about the M16A2's burst mechanism and relatively high cost. The French FMAS is not favored due to its non-NATO-standard accessories; the Spanish CETME is considered to be of unsuitable quality; models of the British bullpup design are considered to be heavy



for the small Thai troopers; weight of the Galil is also a factor which seems to favor adoption of the Steyr; South African designs based on the Galil were withdrawn early on as they were considered to be too similar to the Galil. Thai ordnance officials wish to purchase the initial 10,000 rifles, then produce subsequent weapons locally.

AMOCO SHAREHOLDER FLAP OVER SLORC DEALS

Amoco has filed a petition with the SEC to allow it to ignore a shareholder resolution demanding the company quit doing business with the tyrannical Burmese State Law and Order Restoration Council (SLORC) and its affiliated businesses. As the Senate Foreign Relations Committee noted, "Thousands of civilians have been killed, arrested, tortured, or forced out of the country as a result of brutal government repression ... we continue to be deeply concerned by the gross abuses perpetrated by

... [SLORC] against the people of Burma."

As one of the few friends the Karens have in Burma, we're concerned too. Every day that SLORC survives because some "any-politics-as-long-as-it's-profitable" company continues to prop them up, it costs the lives of innocents. These "American" companies are involved in deals with SLORC: Amoco, Texaco, Pepsico, Sears Roebuck & Co., Wal-Mart. Think about *that* if you don't want the money you spend to end up with blood on it. And tell these turkeys you are going to buy Phillips 66, Coca-Cola, Montgomery Wards and K-Mart products instead of theirs. They won't listen to shareholders, but they *have* to listen to customers.

CANADIAN VIETNAM VETS MEMORIAL

The first Canadian Vietnam Veterans Memorial has been located in Melocheville,

Quebec, off Route 132. This recognition of the nearly 30,000 Canadians who served in Vietnam is long overdue, and masonry work is in progress as we go to press, with dedication slated for fall 1994. Further information on the memorial is available from Canadian Vietnam Veterans Quebec, Box 91, Beauharnois, PQ J0N 3C1.

RELIABLE FIND-A-VET SERVICES

In roughly one-year cycles comes a rash of new "find-a-vet" and "buddy locator" services. We get many complaints regarding ones that are worthless, either because the proprietor thereof is no good at what he does, or because it was a scam from the git-go. Two we feel are competent and honest are: Scrivelsby, phone: 503-297-5402; and American War Library, phone: 310-373-6597. Readers also report good results from ads in *VFW* and *American Legion* magazines. ✕

Dear Mom, We just got in from the bush. I have three confirmed kills already. It's not like the movies...

Joe Ward's Vietnam was one few men experienced—and even fewer wrote about. *Dear Mom* is his true story of what it was *really* like to be a Marine sniper in Nam. It's the kind of reading you can always expect once you join *The Military Book Club*!

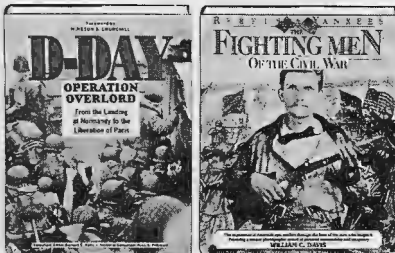

4218-9999* \$24.95x 3012 \$12.95x

GET THIS BOOK FREE
plus
3 more for 98¢ with membership!



3947 \$29.95 4531-9999* \$29.95 3582+ \$21.95 2915+ \$19.95 3848 \$25.00 1826 \$25.00



6429 \$12.95x



6791+ \$14.95 3772+ \$15.95 4101-9999* \$24.95 2949 \$22.00 5157 \$24.95 1891 \$23.00 0547 \$21.95 3905 \$29.95 2717 \$27.50 2279 \$23.00



5777 \$35.00 3046 \$19.95 5256 \$19.95x 4721 \$12.95x 3475 \$16.95x 2303 \$12.95x 0240 \$24.95 4671++ \$22.00 1776 \$22.50 1677 \$24.95 8219+ \$9.95x

HERE'S WHAT YOU GET WHEN YOU JOIN...

A GUARANTEE OF SATISFACTION. Once your membership's accepted, we'll send the 3 BOOKS you've chosen plus *DEAR MOM—A SNIPER'S VIETNAM*. If you're not 100% satisfied with the 3 books, return them within 10 days at our expense. Membership will be canceled and you'll owe nothing. *DEAR MOM—A SNIPER'S VIETNAM* is your free gift to keep.

THE FREE CLUB MAGAZINE. You'll receive up to 16 issues a year. Each issue reviews the Featured Book Selection(s) plus a wide variety of alternate books from the Club's extensive library.

SHOPPING MADE SIMPLE. To get the Featured Book Selection(s), do nothing—it will be sent automatically. If you prefer another book—or none at all—simply return your Member Reply Form by the specified date. A shipping and handling charge (and sales tax, where applicable) is added to each order.

HUGE DISCOUNTS ON HARDCOVER BOOKS. Save as much as 30% off publishers' edition prices. Club books are sometimes altered in size to fit special presses.

AN EASY-TO-MEET OBLIGATION. Take up to 2 years to buy 4 more books at regular low Club prices. Afterwards, you may resign membership anytime.

RISK-FREE RETURN PRIVILEGES. If you get an unwanted book because your Club magazine was delayed and you had less than 10 days to respond, simply return the book at our expense.

Prices shown are for publisher's hardcover editions.

Club hardcover editions save you up to 30%.

*Counts as 2 choices x Special edition exclusively for Club members + Softcover ++Fiction

THE MILITARY BOOK CLUB® ★★

Your #1 Source for Military Books

YES! Please enroll me in *The Military Book Club* according to the risk-free membership plan described in this ad. Send me *DEAR MOM—A SNIPER'S VIETNAM* FREE, plus the 3 BOOKS I've indicated. Bill me just 98¢, plus shipping and handling.

SAVE MORE—BUY YOUR FIRST BOOK NOW FOR \$3.99

Send me the book I've indicated and reduce my commitment to only 3 more books. Bill me an additional \$3.99, plus shipping and handling.

Mr./Mrs. _____
Miss/Ms. _____
(please print)

Address _____ Apt. _____

City _____ State _____ Zip _____

Members accepted in U.S.A. and Canada only. Canadian members serviced from Canada, where offer is slightly different. Sales tax added where applicable. We reserve the right to reject any application.

MAIL TO: *The Military Book Club*
6550 East 30th Street
P.O. Box 6357
Indianapolis, IN
46206-6357

Please write book numbers here: If you already own the FREE book offered, you may substitute for it. Simply cross out the book #6429 and write in the number of the book you prefer.

| | |
|-----------------|----|
| FREE BOOK #6429 | |
| 48703 | 48 |
| 48704 | 50 |

If you select a book that counts as 2 choices, write the first 4 digits of the book number in one row of boxes and 9999 in the next.

SLICK WILLIE WATCH

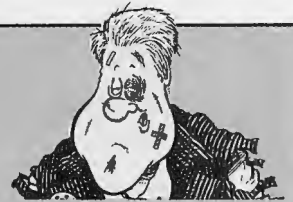

CLINTON DEATH CLOCK

Great sport was had after the assassination of President Kennedy by those of mathematical bent who kept track of persons associated with various independent investigations of the Dallas shooting, who woke up dead before their time. The odds were astronomically against so many purely accidental deaths, they said, which in turn was read by them as proof there was a deadly and massive cover-up. Maybe so, maybe not. We may never know.

But just for fun, we'll keep a running tally of deaths, assaults, burglaries and other misfortunes that befall those who may have been party to, or had damning knowledge of, the Whitewater or other Clintonesque misdeeds, cor-

ruption or juicy bits well worth covering up. Of course, Arkansas life insurance actuaries may have already done this.

A recent editorial in the *New York Post* notes "...there's also no good reason that a stench reminiscent of banana republics and two-bit police states should be coming from Little Rock." We agree. We'll try and keep the tally, and let you try and figure the odds:

Vincent Foster, a long-time associate of the Clintons' who came to Washington with them, was detailed to figure out their Whitewater tax returns (years late). Shortly after he completed the job, and the same day the FBI was granted a warrant to search the offices of Clinton associate David Hale (who has since cut a plea-bargain deal

with Whitewater Independent Counsel Robert Fiske), Foster was found dead of gunshot wounds, a very suspicious "suicide." (See "Who Killed Vince Foster?" *SOF* June '94.)

Luther "Jerry" Parks, owner of American Contract Services, provider of security guards to Clinton's presidential campaign and transition HQ in Little Rock, was shot dead by 10 rounds from a 9mm semiauto pistol while driving home from a restaurant last September. Shortly after Parks' killing, his phone lines were cut, the home broken into, and files Parks had been keeping for six years on "Clinton's infidelities" were stolen. Parks' son says, "I believe they had my father killed to save Bill Clinton's political career."

The Leader In Technology for Seeing, Sighting, Photographing and Videotaping In The Dark

NIGHT VISION WEAPON SIGHTS & VIEWERS



I GEN.
AN/PVS-2B
Weapon Sight
\$1695⁰⁰
Plus \$100⁰⁰ for weapon mounting



I GEN.
SC/PVS-200
Viewer
\$1695⁰⁰

II & III GEN.*
AN/PVS-4
Weapon Sight
\$2850⁰⁰
New with Excellent Cond. Intensifier *III Gen. POR



III GEN.
OSPREY
Mini-Weapon Sight
\$5800⁰⁰
NEW UNIT



II GEN.
SC/PVS-400
Viewer
\$2995⁰⁰



II GEN.
NVG-500
Starlight Goggles
\$5850⁰⁰
NEW

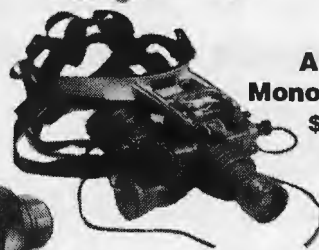

III GEN.
AN/PVS-7B
Mono-Tube Goggle
\$4850⁰⁰
(Standard Unit)



II & III GEN.*
NIGHT EXPLORER
Pocketscope
\$2195⁰⁰
New with Excellent Cond. Intensifier *III Gen. POR



STANO Components

Catalog \$4⁰⁰

P.O. Box 2048 • Carson City, Nevada 89702 • (702) 246-5281 / (702) 246-5283 / Fax (702) 246-5211

ANOTHER PEACETIME CASUALTY

You don't have to be in the service to appreciate a good boot. But it helps.

We don't cement our EVA midsoles and Vibram® outsoles to the uppers, we stitch them. That way they can be resoled some day.

Thirty-mile forced marches, maneuvers in Alaska—it's familiar territory to a company

that began outfitting loggers and trappers 54 years ago.

So we weren't surprised to hear a while back that some lieutenants from Fort Lewis were buying our boots and dyeing them.

"Why don't you make these in black?" they asked.

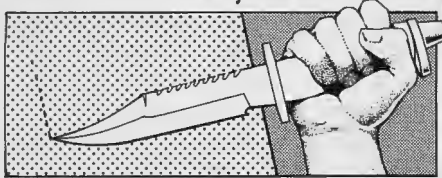

Our 1000 denier Cordura® nylon insets have ten times the tensile strength of leather. And less than half the weight.

That sounded like an order to us, so we had our full-grain leather tanned black inside and out (that way it doesn't show white at the



One firefighter said our Thinsulate® insulation was so good he couldn't tell his boots were on fire.

seams), cut it two inches taller at the top (so you can tuck your pants in), and added D-rings (for dress wear).

And now we're even taking orders from raw recruits. All over the country.

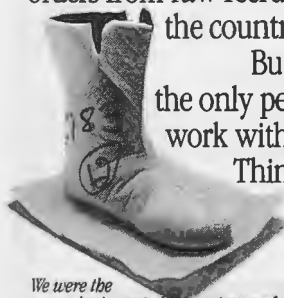

We were the ones who invented the waterproof Gore-Tex™ liner seven years ago.

But you're not the only people who work with your feet. Think of the police. Firefighters. Letter carriers. We did, and we now offer the full range of service footwear, including the only walking shoes



with components proportioned to size. And with heel wedges designed to disperse shock.

No matter what you do, call Danner for the boots and shoes

to do it in. Because chances are it's not your feet that are killing you. Chances are it's the other way around.

Danner

Call us for a free brochure or the name of your nearest Danner dealer.
1-800-345-0430.

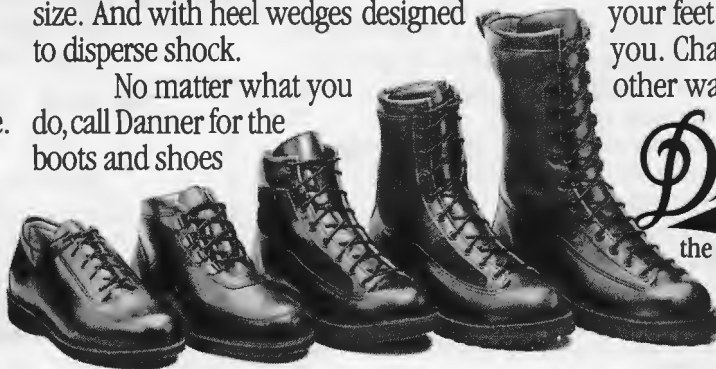

Herschel Friday, an experienced pilot and head of Friday, Eldredge & Clark (Arkansas' largest law firm) and a member of Clinton's presidential campaign finance committee, crashed and died in his plane in Little Rock last March when landing at his private airfield. "He had landed there so many times," said his wife. "He was a very excellent pilot."

L.J. Davis, a Harper's Magazine contributing editor who wrote a detailed, highly critical essay of Clinton's bimboism in *New Republic*, was on a trip to Little Rock to research a piece he was writing on the Rose Law Firm (Hillary's old cohorts), when he was beaten over the head entering his hotel room. He regained consciousness four hours later and found that his wallet and valuables were untouched ... but four pages of notes on the Rose Law Firm were missing. Davis had previously received phone calls from a high government official in Washington who cautioned, "You've gotten into a red zone."

Ambrose Evans-Pritchard,

Washington correspondent for the London *Sunday Telegraph* and contributor to *The Wall Street Journal* and *National Review* was to meet with an Arkansas dentist who was going to share "some knowledge of a sensitive nature" about personalities and transactions in Clinton's home state. Evans-Pritchard got a call from the man who arranged the meeting, saying "They got him last night." The dentist apparently was Dr. Ronald Rogers of Royal, Arkansas, killed with three others in an unexplained plane crash near Lawton, Oklahoma.

In addition, women who have been linked romantically to Clinton (Bill) have been threatened with physical violence if they talk about their contacts with the president. Unexplained fires and accidental shredding and translocation of documents are deemed too routine for this tally.

WHERE'S THE BEEF?

Democrats like to speak of the prosperous Reagan years as "the Decade of Greed." Yeah, OK, sour

grapes. We'll agree, of course, that commodity speculation, insider trading, savings and loan abuses, low-level real estate scams and the like are pretty sleazy, since we're oriented toward producing goods or services for profit. But guess who led the way to the '80s, "The Decade of Greed?"

In '78 and '79 Hillary Rodham, as she was then known, made a minor killing — \$100,000 — speculating in beef futures under the guidance of James Blair, then outside counsel for Tyson Foods. Bill Clinton was then attorney general of Arkansas, soon to be governor. Was this flash-in-the-pan profit for Hillary just exceptional skill and cunning? We doubt it: A Columbia University law professor who examined the Clintons' tax returns told *Newsweek* she did not use her own money; the White House says she started with \$1,000 of her own. In either case, whether or not the seed money was her own isn't what strikes us.

What strikes us is that she quit when she had a winning hand. ✕

BUILD YOUR OWN FIGHTING SHOTGUN!



**Do It While
You Can!!!**

**— ORDER TODAY —
(314) 669 - 5319**

| | |
|--|---------|
| Tactical Grips - (front)..... | \$18.00 |
| (rear)..... | \$15.00 |
| Models to fit Mossberg 500 - 600; Remington 870 Winchester 1200 - 1300. Specify shotgun & front or rear. | |
| Magazine Extensions | \$29.95 |
| 7 shot for Remington 870, 1100, 11-87 — 8 shot for same guns — 7 shot for Winchester 1200, 1300. All for 12 ga. | |
| Shell Follower, High Visibility | \$5.95 |
| Barrel/Magazine Clamps | \$5.95 |
| 2 different models fit all above guns. Specify shotgun. | |
| QD Swivel — fits above clamps | \$4.95 |
| Universal Barrel Shroud | \$15.95 |
| 13 3/4 in. long. Fits most 12 ga shotguns without vent rib. | |
| SideSaddle® Shotshell Carrier | \$24.95 |
| Models to fit Remington 870, 1100, 11-87; Mossberg 500, 600; Winchester 1200, 1300; HK Super 90. Specify gun. | |
| Tactical Sling | \$16.95 |
| 1" Plain Carrying Sling | \$2.95 |

| | |
|---|---------|
| Jumbo Head Safety | \$8.00 |
| Fits Remington 870, 1100, 11-87. | |
| T-45 Tactical Flashlight | \$29.95 |
| (includes batteries and nylon carrying pouch) | |
| Universal Barrel Mount #3 | \$19.95 |
| Mounts T-45 flashlight to shotgun as above. | |
| Tactical Shotgun Case (Fits 18 - 20" with pistol grip) | \$29.95 |

Moore Technical Industries

P.O. Box 86 - Dept SOF
Bowling Green, MO 63334

We stock the entire TacStar® line of laser sights, flashlights, shotgun accessories. We also carry shotgun accessories by Scattergun Technologies® plus much more. Send \$2.00 for our complete catalog. Refunded on first order. Free with order. FAX (314) 669 - 5684
Add \$5.00 for UPS shipping. We accept MO, Visa, MC, or Cash Only COD. **No checks**, please. We ship only to the United States. Tactical Equipment for Prepared Americans

SURVEILLANCE

Pinhole CCTV Camera System

Complete pinhole system includes; 4mm pinhole lens, mini-CCD camera, mount, B&W monitor, cable, power supplies and a 24-hour time lapse VHS recorder. Retail \$3,650. **SALE \$2,495** (ship/ins \$35).

Disguised cameras from **\$495**. (Smoke detector, emergency lights, etc.)



COVERT VIDEO SPECIALISTS

Wireless Video Transmitters & Receivers. Call.

Complete CCTV system design and installation available worldwide.



Match Box Transmitter

TK-100 Tuneable FM Transmitter Kit* with matching receiver **\$199** (ship/ins \$7).

TK-500 UHF Crystal Controlled Professional Transmitter Kit* **\$349** (ship/ins \$7). Available

on two frequencies. Extra lithium batteries \$8 each. Professional High Gain Two Channel Receiver **\$1,200** (ship/ins \$20).

Telephone Transmitter

TK-200 FM Tuneable Transmitter Kit* with tunable receiver **\$199** (ship/ins \$7).

TK-600 UHF Crystal Controlled Professional Quality Transmitter Kit* **\$399**. Two frequencies available. Works with scanner or professional high gain receiver.

***NOTICE: Transmitter kits require simple (10 minute) final assembly.**



- **Body Wire and Receiver Set \$299** (ship/ins \$10)
- **Body Wire Detector \$695** (ship/ins \$10)
- **Complete Basic Countermeasures Kit \$1,495** (ship/ins \$35)
- **Tap Nullifier. Jams telephone taps. \$695** (ship/ins \$10)

Audio Surveillance Kit

Includes;

Body wire and receiver,
VHF crystal controlled
Telephone recording system
Mini microphone w/amplifier
and 25' cable
FM Match Box Transmitter Kit
FM Telephone Transmitter Kit

Receiver for FM Transmitter
Touch Tone decoder
Call Logger
Lineman's handset (telephone)
Contact microphone
Telephone Infinity Ear
Taps & Bugs Video

Assembled in a briefcase. **\$1,495** (ship/ins \$25).

Telephone Recording System

Complete system includes; extended play recorder, 140 minute cassette, power supply, telephone interface for standard single and multi-line telephones, alligator clip adapters for attaching the recorder anywhere along the telephone line. Includes everything you need to record your calls.

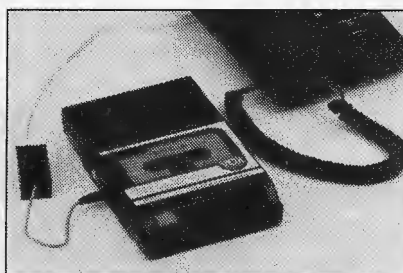

Starts and stops automatically. Voice activated. Optional "beep" mode. **EP-500 Telephone Recording System \$195** (ship/ins \$7).

Record for 12 hours with EPPI's **Professional Model Pro-12 Telephone Recording System \$399** (ship/ins \$19).

- **Call Logger II** - keeps an electronic record of all OUTGOING calls (phone numbers) made from any single line telephone. Even shows local numbers that your phone bill won't. Attaches anywhere along the line. **\$189** (ship/ins \$10).
- **Telephone Taps and Room Bugs**. How they're done and how to defeat them. Surveillance expert reveals trade secrets, step by step. Shows many of the actual devices. One hour VHS **\$49.95** (ship/ins \$4).
- **Israeli Instinctive Combat Shooting Method**. One hour step by step lesson. Filmed in Israel. VHS. Retail \$49.95 **Limited Offer \$29.95** (ship/ins \$3).



KGB Photo Sniper System

Camera, shoulder stock, 300mm lens, filters, carrying case etc. A tremendous value. **Only \$599** (ship/ins \$25). This is THE system used by surveillance teams in former East Block Countries.



Night Vision

WARNING!

Not all Russian night vision is equal. Don't get burned buying cheap junk or units that produce dangerous x-rays.

- Binoculars
- Riflescopes
- Handheld viewers
- Complete camera systems

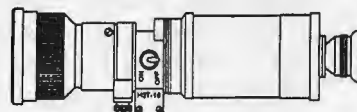

Invest in quality at excellent prices. Call EPPI.

NOTICE! These products are intended and sold only for the purposes of testing and experimentation and training in electronic countermeasures. Any other use may be illegal. FCC licensing may be required prior to assembly. Not to be used for surreptitious interception of oral communications. All equipment is sold subject to public law 90-351, title II, 18 U.S.C. Section 2511. All local, state, and federal ordinances, rules, regulations, etc. It is the sole responsibility of the buyer (not the seller) to consult legal counsel for interpretation of any laws applicable to the area of intended use.

Catalog
\$5



Surveillance/CounterSur.

Hands-on Seminars

Two days - held bi-monthly

\$495

Call for dates and reservations

Executive Protection Products, Inc. - The Professionals

1325 Imola Ave. W. #504S, Napa, CA 94559 **707-253-7142** FAX 707-253-7149 MC/Visa

I WAS THERE

by Mike Williams

The Old Man And The Tea (House)

My first assignment in Korea ended somewhat abruptly after I chased two Oriental MPs off with a Thompson submachine gun. (They all looked alike to me...) Soon thereafter, I found myself assigned to the 3rd Partisan Infantry Regiment (Airborne), United Nations Partisan Infantry Korea (UNPIK—formerly UNPFK, United Nations Partisan *Forces* Korea—changed because too many people were referring to us as “Unfucked.” UNPIK designated us as *infantry*, which meant we could get the CIB.)

Based in the Chiri-san mountain range of North Korea, the 3rd was the only airborne regiment in UNPIK and had a full complement of veteran airborne officers and NCOs. Our battalion strength varied: Sometimes I had as many as 1200 swinging dicks under my command, often a lot less.

Almost all the partisans in UNPIK were deserters who'd split off the main body of North Korean and Chinese troops during the advance down the peninsula. They joined UNPIK by the thousands and were paid in rice for their service to the U.S. Army. There were times, however, when some of the partisans felt that the food and conditions weren't to their liking so they just split and went back to their old units— not too far north of us, near Wonsori. This round-robin pilgrimage made everybody nervous.

The nearest point of any consequence was the small fishing village of Sok Cho huddled on the beach facing the Sea of Japan. Sok Cho looked as if it had been uprooted from the 17th-century Manchu dynasty; fish racks dotted the beach and a strong breeze carried the smells of drying fish and *kim-chi*.

The center of entertainment in Sok Cho was a small building that housed the Mah-Yang tearoom. God knows when it was built, but



All manner of Korean troops fought under U.S. command during the Korean War. North Korean and Chinese deserters were formed into “partisan” infantry units commanded by American officers. Photo: AP/Wide World

there was a gnarled tree growing from the dirt floor right through the center of the roof. But it wasn't the tree that caught my eye. It was Miss Kim, the head—and only—waitress at the Mah-Yang.

For three weeks I tried every damned move I could think of to get her on her back. No joy! Finally, I got Major Yoh, my Chinese bodyguard, interpreter and RTO, to approach the old papa-san who owned the place and ask him how much he wanted for Miss Kim.

He wouldn't talk about selling Miss Kim. What he did offer was to sell me the tearoom and throw in Miss Kim to boot. “Papa-san say he want \$2 million *hwan* for tearoom and Miss Kim,” Yoh translated.

“Two million?” I shook my head.

“Maybe not bad idea ... can run tearoom and collect money from fishermen. Yes, good idea!” Yoh bobbed his head and grinned.

So the next morning, we returned to the Mah-Yang with two small wooden footlockers full of Korean currency. There followed a round of excited jabbering in Korean and Chinese between Yoh and the owner.

Yoh shoved some papers over to me and soon it was official; the Mah-Yang tearoom now belonged to the 7th Battalion, 3rd Partisan Infantry Regiment—complete with tree and Miss Kim.

“Papa-san say Miss Kim home resting ... she be here tomorrow all dress up for you.”

I hoped Miss Kim had a pair of GI long johns on for what was planned.

It was nearly noon the following day before I could get away from the battalion and start for Sok Cho, accompanied by Yoh and the bodyguard detail.

The tearoom looked deserted when we drove up: No smoke was curling up from the hole in the roof, nor was there any sign of fishermen straggling in and out of the entrance. Yoh snapped off a command to the bodyguards and they jumped out of the jeep and ran around to the back of the building; a few moments later they reappeared and reported to Yoh. He turned to me and shook his head, “Numbah fuckin' 10! Papa-san and Miss Kim run away ... take money!”

I couldn't believe the little North

STEROIDS

ALTERNATIVES

ALL PRODUCTS 100% NATURAL
NO HARMFUL SIDE AFFECTS

- 1** **DIBENCOLIDE 10 mg** is the most powerful steroid replacement on the market & 100% legal. World records have been set while using this product!
2 month cycle \$22.50
- 2** **BORON 10 mg** naturally enhances testosterone levels so you can build muscle *without the harmful side effects of illegal steroids.*
3 month cycle \$15.95
- 3** **GROWTH HORMONE RELEASER G.H.R.X.** Releases growth hormone in an abundance like no other. *Works great with Boron.*
60 tabs \$21.00
- 4** **LEGAL STEROL COMPLEX** enhances growth. Allows body to stay pumped longer. Releases growth hormone and *strips away fat!*
60 tabs \$19.95

LIFETIME 100% MONEY BACK GUARANTEE

Buy Products 1, 2 & 3 and get #4 FREE. This will enable you to have the most powerful natural anabolic stack on the market.

ORDER NOW! C.O.D.'S WELCOME

1-800-398-6946 *Ask for ext. 120*

Send Check or M.O. (Add \$4.00 for shipping)

S&K LABS

2637 E. ATLANTIC BLVD., SUITE 101.
POMPANO BEACH, FL 33062

COD

TACTICAL ELECTRONICS

LASER GUNSITE



DANGER
Class IIIA Laser Product
LASER RADIATION
Avoid Direct Exposure
to Eyes

Easily mounted, ready to use
LATR1.....\$174.50

BLITZER STUN GUNS



Hard Hitting
Made in USA

- | | |
|------------------------------|---------|
| STUN1 80KV, Curved Grip..... | \$49.95 |
| STUN2 100,000 Volts | \$59.50 |
| STUN3 120,000 Volts | \$69.50 |
| STUN4 150,000 Volts | \$89.50 |

Caution -
Check
Local
Laws

Long Range Voice & Telephone Transmitters Combo

Easy to Assemble Kits

#XFM/XTL300 (Special 2 in 1).....\$34.50



CRIMESTOPPER!



Self Defense Weapon

- Stops an attacker up to 8', also dogs
 - Contains identification dye markings
- BLTZ1 Multi-shot, key ring att.\$9.50

Complete Brochure FREE With Any Order!
PLUS Explosive Paint Plans! 2 part mix, labeled dangerous, \$5.00 value!

AMAZING CONCEPTS

ORDERS: 800-221-1705 - FAX 603-672-5406

Send Check, Cash, Money Order, COD, MC, Visa to:
Dept SF2, PO Box 719, Amherst, NH 03031

Korean prick had ripped me off! While I was grinding my teeth and cursing my overactive sex drive, one of the local fishermen wandered up. He jabbered away with Yoh for a few seconds and then pointed down the road in the direction of Kangnung.

"Papa-san and Miss Kim go Kangnung maybe one hour." Both were afoot and running. If they stayed to the road our chances of catching them were good, but if they stopped anywhere along the route at any of a dozen friends' houses, it would be like finding the proverbial needle.

I needed more help than what I had along. The quickest solution jumped immediately to mind: I radioed battalion and contacted my operations officer. I explained that I wanted one rifle company dispatched in trucks to my location as fast as possible — to search for reported guerrillas who had infiltrated. The last part of the transmission was accurate because there were always reports of infiltrators.

Yoh had a quizzical expression on his face. "I think we have *tock-san* [big] trouble if CO find out." The regimental commander was at 8th Army HQ in Seoul and wasn't expected back for several days.

"Don't sweat it, Yoh ... We'll find papa-san and Miss Kim in a couple of hours and nobody'll know anything."

As the trucks bearing the rifle company arrived, I briefed the company commander on what I wanted; I gave him a description of Miss Kim and papa-san and told him they had run off with money that belonged to us without fulfilling their part of a contract. They were to be picked up and brought back ... with the money!

The prospect of a hunt fired up the troops, and they were grinning like Cheshire cats as the trucks roared off down the dirt road.

By 1630 there was no sign of our quarry. They had vanished with no trace and left me with one rifle company hiking through the cold, with nothing but frostbite to show for their efforts.

At the southern-most point of

Continued on page 62

ONE TOOL DOES IT ALL!



HIKER'S HATCHET
serves as a hatchet,
hammer, filleting tool,
knife and saw!

"Outdoor dudes and outdoor distributors will definitely want to check this one out." — *Soldier of Fortune Magazine*, April 1994

Only \$89.95 + shipping

ORDER YOURS TODAY

Call D-Pack ~~Recreation~~ at LA²

505-293-3400

or fax your order to

505-293-3889

Mail to: D-Pack Recreation, Inc.
4550 Eubank Blvd. NE, #108, Albuquerque, NM 87111

NIGHT VISION ELECTROPTICS

NEW THIRD GENERATION NIGHT VISION SYSTEMS

SCOUT PVS-7B BLACKCAT

POCKETSCOPE GOGGLE GEN III 1X LENS I.R. LIGHT MINI-WEAPON SIGHT

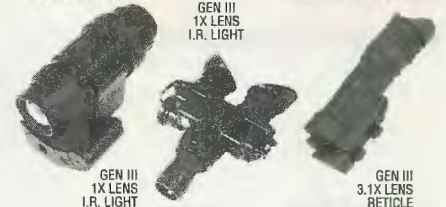

\$3,450. \$3,995. \$4,850.

RECONDITIONED UNITS AT OVER 50% SAVINGS

PVS-5 NIGHT STALKER PVS-7A



STARTING FROM **\$2,495.** STARTING FROM **\$1,395.** STARTING FROM **\$1,995.**

(916)784-3316 / (916)774-7525
SEND \$1.00 FOR A CATALOG TO:
NORTH AMERICAN INTEGRATED TECHNOLOGIES
1911 DOUGLAS BLVD., SUITE 85-104
ROSEVILLE, CA 95661

WORLD SITREP

1

UNITED STATES

Due to lack of funds for parts and depot-level maintenance, USMC reports equipment readiness below 90% for first time in 10 years. Current projected budgets make it impossible to reverse this trend.

State Department's key policy planning staff is being reduced and put under direct control of left-wing Strobe Talbot. The office had previously been kept independent of control by political appointees in order to maintain long-term consistency in U.S. policy.

Stung by criticism of its too-generous awards policy in Gulf War, Navy rules that sailors and Marines in Somalia are only eligible for Combat Action Ribbon if they were actually in combat. Coming under occasional fire is not enough; the serviceman must have been under repeated combat or at least have fired back when fired upon.

5

SOMALIA

Marine Colonel Matthew Broderick supervises U.S. troop withdrawal, leaving about 50 Marines at U.S. Embassy. As a captain, Broderick commanded evacuation of U.S. Embassy in Saigon in 1975.

Aidid demands U.N. pay reparations for 13,000 Somali civilians he says were killed by U.N. forces, as well as 45,000 he claims were wounded.

10

NORTH KOREA

Bans domestic travel, puts army on alert, and warns its people "war is inevitable." Russian Deputy Foreign Minister Alexander Panov says Russia would be obligated by treaty to side with North Korea if attacked.

U.N. Security Council approves mildly worded Chinese draft calling for North Korea to allow nuclear inspections, but not imposing penalties if it refuses.

6

MEXICO

Ruling party presidential candidate Luis Donaldo Colosio is assassinated, throwing elections into an uproar as party scrambles for new candidate.

1

6

12

11

INDIA

Indian border guards wound three Pakistani civilians, and police kill eight Kashmiri militants.

India opposes U.S. sale of 38 F-16s to Pakistan. Pakistan says it will not accept U.S. conditions capping their nuclear program.

7

BOSNIA

Serbian tanks assault outskirts of Gorazde as troops have trouble making headway against Muslim defenders. U.S. Chairman JCS General Shalikashvili and Defense Secretary Perry say air strikes will not save the enclave. Serbs interpret this as a green light, and move tanks into position and begin firing into city. A British SAS team in Gorazde calls for NATO air strikes. Two U.S. F-16Cs destroy two Serbian tanks.

Next day, Serbs continue their attack and two USMC F-18s destroy three armored vehicles and a truck. In spite of NATO air strikes, Serbian shelling continues.

Serbian troops in Sarajevo become openly belligerent to U.N. forces and refuse to allow relief works move around city.

12

EL SALVADOR

U.S. military officer is killed by grenade during attack on police station he had been visiting.

14

2

RUSSIA

Has been secretly destroying chemical weapons for last eight months without international inspection to cover-up its higher-than-admitted stocks.

Current polls show 21% of parliament believe Alaska legally belongs to Russia, 50% believe it belongs to United States, and 29% refuse to answer.

Is target for dozens of espionage agencies, including former Soviet republics, Third World countries seeking technology, and criminal gangs.

3

ZIMBABWE

In a major scandal, farms taken from white farmers at confiscatory prices are being leased by senior black officials rather than distributed to landless peasants. This unsettles white farmers in neighboring South Africa.

4

SOUTH AFRICA

ANC activists open fire on Royalist Zulu demonstrators in Johannesburg killing at least 51. President de Klerk formally imposes a state of emergency in Natal, the Zulu homeland, and sends in troops. Bloodshed continues across the province.

2

8

ISRAEL

Hamas suicide car-bomb slams into a bus in Afula, killing eight and wounding 50. Israel seals off occupied territories indefinitely, but says attacks on Jews will not slow peace talks.

Rabin says Israeli withdrawal from Gaza and Jericho could be delayed till mid-May.

9

YEMEN

Peace talks in Oman between Saleh and al-Baidh collapse, raising specter of a Somali-style civil war. Both sides accuse the other of massing troops. Mediators are producing no appreciable results.

7

8

9

5

11

13

RWANDA

Burundi President Cyprien Ntaryamira and Rwandan President Juvenal Habyarimana are killed as Rwandan presidential jet is shot down by shoulder-fired missile while landing at Kigali. Intertribal fighting erupts immediately and rages across country. Presidential Guard, a Hutu unit, begins massacring Tutsi civilians and kills prime minister and 11 Belgian troops trying to protect her. Tutsi RPF rebel troops retaliate against Hutus.

France sends more than 400 troops into Kigali airport. U.S. sends 330 Marines to organize convoys to evacuate civilians, and Belgium sends 800 paratroopers to protect its citizens. Nearly all foreigners are evacuated by air or convoys.

13

3

4

14

BRITAIN

Is decommissioning one of its four new Upholder class diesel submarines, and will decommission the others later this year. Designed to patrol shores of Iceland and Greenland for Russian submarines, they are no longer needed and are being offered for sale to India, Pakistan, Malaysia and Saudi Arabia.

World SitRep is excerpted from the biweekly newsletter *For Your Eyes Only: An Open Intelligence Summary of Current Military Affairs*. Published by Tiger Publications, P.O. Box 8759, Amarillo, Texas, 79114-8759; subscriptions are \$65 per year (26 issues). Sample issue available for \$3. Those interested in reliable, up-to-date world intel are encouraged to subscribe.

15TH ANNUAL SOF CONVENTION

SEPT. 14-18, 1994
SANDS HOTEL,
LAS VEGAS, NEVADA

FREE T-SHIRT
EXCLUSIVELY FOR
CONVENTIONEERS

You work hard and you deserve to play hard, too. Especially when having a good time also builds your skills and knowledge. Come enjoy five action-packed days and nights at this year's SOLDIER OF FORTUNE Convention. We promise non-stop activities, including:

PUGIL STICKS — and other competitive matches. Get in shape now so you can compete for cash prizes. Your body will thank you — so might your wallet.

SEMINARS — Topics ranging from combat weapon usage to military sitrep reviews, police tactics and survival in modern times. Learn the truth firsthand from the men who have been there. Free admission only to registered conventioners.

EXPO — Check out the latest in weaponry, ammo and other merchandise from over 400 exhibitors. Runs Friday, Saturday and Sunday. Free admission to registered conventioners.

PARTICIPATORY EVENTS — Receive expert training in a large range of courses including parachuting & weapons training.

THREE-GUN MATCH — Prestige and cash prizes for expert shooters and those who aspire to be (see separate ad in this issue).

FIREPOWER DEMO — An awesome display of firepower caps off an action-packed day at the range: team shoot-offs, manufacturers' new-product demos, skydiving, big guns & explosives. All day Saturday — free to conventioners.

BANQUET — Saturday night Awards ceremony features insightful speakers and savory cuisine. Dress is casual.



1994 SOF CONVENTION PRE-REGISTRATION FORM

Yes! I want to be a part of the 1994 Convention

Check or money order enclosed. \$135 must be received by Aug. 31, 1994. \$160 after August 31, 1994.

Full refund by 7/1/94
Half refund by 8/15/94
No refund after 8/15/94



Charge \$ _____ to my MasterCard Visa
Card # _____ Exp. _____

Signature _____

Name _____

Address _____ Apt.# _____

City _____ State _____ Zip _____

Phone _____

T-Shirt Size S M L XL XXL (circle one)

Mail with Payment to:

SOF '94 Convention Pre-Registration

PO Box 693, Boulder, CO 80306

Tel. 1-800-800-7630 Fax (303) 444-5617

Early Bird Registration

- First 500 conventioners will receive a 15th Anniversary commemorative pin.
- Twenty names will be drawn from first 500 conventioners — winners join Robert K. Brown for brunch.

COMBAT WEAPONCRAFT

Reaction Reflex

Text & Photo by Gabriel Suarez

Jeff Cooper once related how young Marine officers were cautioned that they might be forgiven for losing a battle, *but never for being surprised by the enemy.*

Being surprised by an aggressor in the field or on the streets can mean defeat, but with a properly trained "combat mind-set" the possibility of being caught unaware is minimal. To stay surprise-proof, anyone under arms must be particularly cognizant of his surroundings. Being human and fallible, our alert combat mind-set sometimes lapses, putting us into the world of unreadiness and condition "white."

Cooper's research shows that if you are startled and attacked while inattentive, trained response is substantially delayed while you catch up mentally: Instead of proper combat response, you get a big flinch. This is the startle reflex.

The startle reflex is characterized by tensing the muscles, hunching the shoulders, and slightly bending the knees while bringing the hands up to protect the face and — worst of all — closing the eyes. This is a reflexive reaction to sudden fright, nothing more: It is no way to win a fight.

Let's examine what our fighting response will be if totally unready. We have established that our trained response will be delayed if we are surprised. The startle reflex is not delayed — it is instantaneous — but that startle reflex may be molded and trained to work for us. *You can convert the frightful flinch into a fighting move! That fighting move can be the first step of the pistol draw: the grip.*

Some have suggested that if you are going to make the grip into a startle reflex, why not make the whole presentation of the weapon a startle reflex. I don't recommend it. We are not discussing a circumstance where we



Threat evaluation should take place from the guard position. The muzzle should be low enough to let you see the aggressor's hands: Once a threat is realized the pistol is brought up to the firing position and business taken care of.

know an antagonist is trying to harm us, where he commits himself enough to warrant shooting him. We are examining a situation where we are not paying attention. Being inattentive, you have no particular target or even a confirmed threat. You don't want to draw and shoot without knowing what is going on, but you *do* want to go for the grip instead of merely recoiling from fright. Drawing and shooting at everything that startles you may be advisable in some countries, but not here. A simple grip response allows assessing the situation and establishing that there is a need to act further. If there is, then you are in the best position to follow through if you have a hand on the holstered pistol.

There are three steps to developing a reflexive tactical response from a startle reflex: The first is to have practiced the full draw several thousand times. Repetition will develop and enhance the neural pathways from the brain to the hand that say, *draw*. This allows the body to

memorize movements and execute them on demand. Do not attempt to force speed, but rather develop smoothness and the correct moves.

Step two is visualization or mental rehearsal. Practiced mental imagery enhances the reflexes that repetition develops. You must know that you will respond when startled as you have trained. In this purposeful daydream you imagine yourself in a calm situation. Then you visualize being startled. In the mental drill, your response to sudden fright stimulus must be as you have programmed yourself. The grip is your initial response and the remainder of the presentation will be a follow-through to deal with the threat.

Step three is to physically practice the drill in real-time. Ready your pistol for dry-firing and observe all the precautions. Holster your pistol. Select a sound to serve as a startle stimulus, such as tape-recorded gunshots. Then rig the recorder to a timer such as

Continued on page 62

by smoke inhalation, as are those who survive a plane crash and subsequently don't make it. Breathe the poisonous products of combustion and you die quickly. Fry your lungs with one good gulp of 1,000-degree gasses and you die later. Best not to do either.

You obviously can't cram a Scott air pack in your carry-on luggage, and you may come across as paranoid by hanging one next to the telephone or refrigerator. But here's a new product that will get you out of the house, plane or bunker with your

lungs and hair intact: the EVAC-U8 emergency escape smoke hood. The EVAC-U8 gives you at least 20 minutes of breathable air by filtering out/detoxifying poisonous smoke. Don't know about you, but if we can see a way out, that's 19 minutes to spare. The unit is about the size of a can of beer, when stowed, and goes on in seconds. The heat-resistant hood affords protection for your head against flame and radiant heat, while letting you see and hear. The bottom of the canister glows strongly in the dark to



aid locating you. This new idea is going to save a lot of lives, and one of those might be yours — for only \$49.95. Contact Brookdale International Systems Inc., Dept. SOF, 1-8755 Ash St., Vancouver, BC V6P 6T3 Canada; phone: 604-324-3822; fax 604-324-3821.

STOPLIGHT

Pepper sprays really work — if you can have your spray can spritzing before you get belted, stabbed or shot. And if you can see your assailant in the dark. And if you hit your attacker in the face. And if you don't get confused and spray yourself. And if a gust of wind doesn't dissipate/blow away the spray mist.

For the first time, these "ifs" have been efficiently dealt with by the Stoplight, an effective pepper spray built into a high-intensity flashlight. Thus you already have it in your hand, and the beam of light acts as your target designator: Where the light hits, the stream of pepper spray hits. And it projects a *stream*, not an easily diffused mist, from the replaceable canister. The safety switch slides to operate the light, lifts to access the spray button, and acts as a guard to prevent accidental discharge. Pepper sprays have always been effective when they hit the target, and now somebody finally got it all together *right*, so for only \$29.95 you can be assured that *it will*. Available from The McLean Co., Dept. SOF, Box 363, Madison Blvd., Canastota, NY 13032; phone: 315-697-7000. ✕

EXTRAORDINARY SURVEILLANCE AND INVESTIGATION AIDS

SURREPTITIOUS SUPPLIES?

Surveillance, counter surveillance, audio surveillance, video surveillance, people trackers, covert entry equipment, night vision, scramblers, and devices to defeat both, aerial photos of anyplace, the MASTER list of information suppliers, specialized newsletters, OEM lock picks, thru wall listeners, reverse engineers, Spy Shops, alternate ID's, non-lethal weapons, program crackers, and much more.

SAVE HUNDREDS, EVEN THOUSANDS OF DOLLARS! Order directly from the original sources. For the first time Læ Lapin, author of *How To Get Anything On Anybody*, publishes his private list of suppliers from the world over. Locate impossible equipment—shop where the smart guys shop. **THE COVERT CATALOG** provides hundreds of addresses, sample pages, catalog prices and recommendations that will save you money on everything from break-in books to undetectable bugs. The latest and the best. Designed for PT's, cops, security folk and those with a need to know...

THE COVERT CATALOG, \$34.95. Hell, you'd spend that much on postage alone...

OPEN ANYTHING

II KILLER KITS WHY OVER BUY? NOBODY NEEDS 100 PICKS...

Kit A features 16 hand finished steel spring picks, assorted tension tools and extractors plus a collapsible CAR DOOR OPENER that

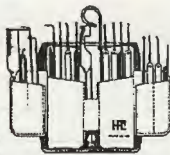

assembles into a Slim Jim or Peg Leg style car popper, all in a shirt picket sized real leather case; PLUS 6 Super Shims that click open virtually any spring live latch bolt in a few seconds...Special Introductory price \$109.50!

Kit B Everything in Kit A, plus a Lockaid Pickgun specifically designed for locksmiths and law enforcement agencies to quick pick pin tumbler locks. \$164.95. Gun alone \$59.95.

Kit C Computer designed rocker picks that open many locks when regular picks won't. Hand finished stainless steel in a clear case. \$79.95

COBRA III—Electronic Lock pick. We've sold them all and now we only sell the one that really works. Designed by the inventor of electronic lock picking the Cobra III+ features a more powerful motor, replaceable/rechargeable hot packs, Halogen light to illuminate the key way, rubber grips and improved picks. Opens 99% of all locks in seconds. \$399.00

PURCHASE ANY OF THE ABOVE AND GET OUR INSTRUCTIONAL VIDEO SUPERPICKING FOR ONLY \$24.95!!

**Note you must be over 21 and in law enforcement, licensed security guard or student locksmith to purchase lock opening devices. By ordering any of these devices you are so stipulating to the above conditions.*

SURVEILLANCE/COUNTER SURVEILLANCE

Automatic Tap Stopper Just designed, first time on the market, this state of the art unit stops most phone tap attacks in their tracks. Beats/defeats

drop-out relays, auto recorder starters, VOX recorders, infinity transmitters, X-phones, room mics (on phone lines) hot hook switches, auto transmitters and most free running transmitters! More Bang for your buck! The ATS will flat out prevent almost every possible telephone tap or room audio (via the phone or phone line) bug. does not interfere with normal calling. **If you value your privacy you need the ATS!** \$495.

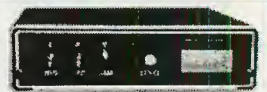

MASTER Z TOOL SET

94 Master Z Tool Set opens over 700 cars with ease. Beats any door cavity locking system and most power lock door switches. Easier to learn, easier to use than those sloppy sets that feature 50 bent wires and a prayer. Never be locked out of your car again. Includes Z tool with depth guides, new system manual, Japanese tool, Autobuster II tool, 2 Flex wedges and a carrying case. \$109.95

VIDEOS

PEOPLE TRACKING

You Can Find Anyone. The definitive work on locating old friends, skippers, heirs, bad guys, good guys. How to info plus sources and short cuts for both beginners and pro's. \$69.95



SUPERPICKING The California lock picking champion along with the inventor of the electronic lock pick show exactly how to pick, rake, spring and generally open pin tumblers, discs, car locks and, well, almost any lock. \$59.95. OR JUST \$24.95 with the purchase of either Killer Pick Set or Cobra III+!

**SEND CHECK OR MONEY ORDER TO:
INTELLIGENCE INCORPORATED
2228 S EL CAMINO, #349 A
SAN MATEO, CA 94403**

Include \$5 shipping. CA residents must include 8% tax.

**ORDERS ONLY:
1-800-805-5544**

(Nice order takers but they have no other information available.)

CATALOG \$5.

Visa and Mastercard accepted

INTELLIGENCE INCORPORATED

PNEU-GUN™

Air Powered Ballistic Baton

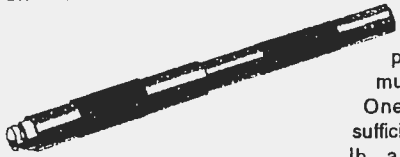

The "PNEU-GUN" (pronounced newgun) is a fistful of security. It is only 14 inches long when assembled and fires out a lead pellet filled "Shotbag" at a muzzle velocity of 250-300 f.p.s. One CO2 gas cartridge supplies sufficient energy to knock down a 300 lb. assailant 20 feet away. The "PNEU-GUN" air powered ballistic

baton is awesome! You have to see it in action to believe just how effective it really is. Don't confuse "PNEU-GUN" with old style "stun guns", "Un-Guns" or "Bean Bag Guns". There is no comparison in power, quality, range, effectiveness or sheer beauty of design. Keep on in your car, next to your bed or handy for that unexpected emergency. The "PNEU-GUN" air powered ballistic baton is the perfect alternative to a handgun. Legal, effective, yet safe to use.

AG1 ... "PNEU-GUN" Airgun Kit ... \$169.95
 (Includes Airgun, 4 Shotbags, 6 CO2 cartridges, 10 gas check, 10 white end caps, loading cartridge, instruction book)

THUNDER BLASTER

This new high tech, electrical self-defense weapon is the stun gun you've been waiting for! Now with a full 150,000 volts of increased power! This gun utilizes two 9-volt batteries and has dual coils. It has an extremely loud electrical sound so it is an even more effective deterrent than most other stun guns. The improved ergonomic hand grip is just perfect for a firm hold. Other features include an easier to use angular trigger, an on/off safety switch, a battery power indicator light, and a built-in belt clip. This gun will visually intimidate an attacker up to 20 feet away.

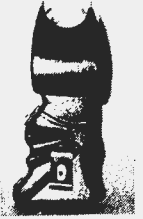

TB-1 ... Thunder Blaster ... \$119.95

THE TERMINATOR Tear Gas Alarm

The Terminator offers low-cost anti-burglary protection. When triggered by the trip line, 4 oz. of CN-type tear gas is discharged. Armored cast aluminum housing, replaceable canister, safety pin to prevent accidental discharge. 2,000 sq. ft. coverage.



TM-1 ... The Terminator ... \$59.95

SAP GLOVES

Made of soft, pliable, ling wearing leather. Has six ounces of powdered lead carefully inserted into the fist of each glove. High quality and available in three sizes, medium, large, and x-large.

DAM ... Sap Gloves ... \$44.95



PHONE CHECK (Telephone Bug Detector)

This unit has both a light emitting diode and a meter read out. Will tell you if your line is interrupted while in use. Will also automatically shut down the line if a bug is detected or an extension is picked up.

ST1 ... Phone Check ... \$79.95

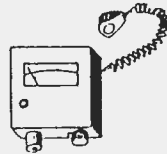

TRANSMITTER (BUG DETECTOR)

Find hidden RF transmitters (bugs) planted in your home, office, car or attached to your telephone line. This device is designed to locate the most common type of electronic bugs. Frequency range of 1 MHz to 1,000 MHz.

TD-17 ... Bug Detector \$98.00

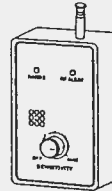

WIRE TAP DETECTOR

The Tap Detector detects series devices with a resistance of 61 ohms or more. It will also detect parallel devices with a resistance of 65 megohms or less.

This device is the best full anti-wireless tap detector for the money. Compact, only 4-1/4" x 3-1/2" x 1-1/2"; and comes with all the necessary plugs, cords, adapters, battery and illustrated instruction manual. Buy this one to sweep the phone line and the Phone Check device to make sure no more taps are put on our lines!

TT-17 ... Tap ... \$99.00

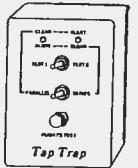

ALASKAN MAGNUM PepperGas®

Alaskan Magnum is an effective easy to use repellent that can be carried by hikers, joggers, backpackers or by anyone that is likely to encounter a violet attack. Utilizing a 10% concentration of pepper, Alaskan Magnum is sure to knock down any attacker. Alaskan Magnum comes in a 9 oz. fogger unit that has a range of 20 feet!

PG9 ... 9 oz. Alaskan Magnum ... \$49.95

PISTOL CROSSBOW

This compact pistol version of the deadly and silent crossbow is now available. This unit has fully adjustable sights, is amazingly accurate, comes in two different versions (50 lb. draw and 80 lb. draw) and comes with three practice arrows.

PC1 ... 50 LB. DRAW ... \$49.95
PC2 ... 80 LB. DRAW ... \$59.95

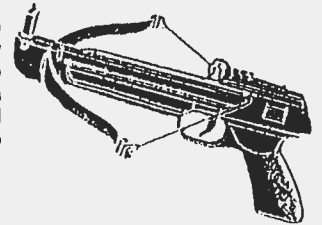

BALLISTIC KNIFE

Congress outlawed the springs which enables this knife to shoot its blade with deadly force. The Ballistic Knife was invented by Russia and issued to their elite "Spetznaiz" forces. This knife based on the original Soviet version which is able to fire its blade silently out of the knife handle with five times the force of a manual stab! This American made copy of far superior to the original and its unique firing ability was so effective, a federal law was made that out-laws and knife with a propelled blade.

Now you can get this knife in kit form. The handle and sheath are made of aircraft grade aluminum. The blade is tempered out of 41040 steel with a rockwell hardness of 56l)

FCC1 ... Ballistic Knife ... \$139.95

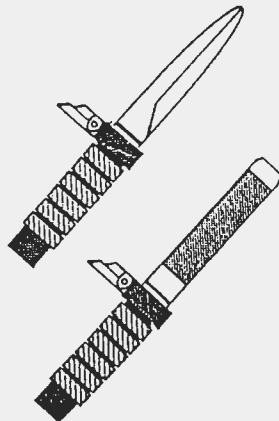

ORDERING INFORMATION

By Mail: Mail coupon or separate sheet with payment or credit card information to:

SONIC TECHNOLOGY, INC. 10105 E. Via Linda, Scottsdale, AZ 85258

By Phone: Call 1-800-538-0787. Have all information ready.

Sonic Technology, Inc. does not warrant that you may legally possess or carry stun guns, pepper spray, etc. By ordering you acknowledge that you are an adult and there are no legal restrictions.

SONIC TECHNOLOGY, INC.

10105 E. Via Linda, Ste. 103-261
 Scottsdale, AZ 85258

1-800-538-0787

| Qty. | Number | Description | Price |
|--|--------|-------------|------------------------|
| | | | |
| | | | |
| | | | |
| | | | |
| Charge My: Visa <input type="checkbox"/> MC <input type="checkbox"/> Amex <input type="checkbox"/> | | | Subtotal |
| Card #: _____ | | | Shipping \$5.00 |
| Exp. Date: _____ | | | Total |
| Name: _____ | | | |
| Address: _____ | | | |
| City/State/Zip: _____ | | | |

FEDS WANT LICENSE TO SPY

As of this writing, the Clinton administration has taken a stand on yet another issue that is potentially devastating to civil rights. In spite of intense pressure from both the commercial sector and private citizens, Clinton has decided to endorse the Clipper chip as the de facto national data encryption standard.

The Clipper chip is intended to be a key component in cryptographic, telecommunications and computer hardware manufactured in the United States.

Each chip will have a particular code it responds to and that code will be known by an agent of the government. When a law enforcement agency receives the proper authorization, the agent will reveal the code and the law enforcement agency will then be able to decode all traffic from a particular Clipper chip — without the owner's knowledge or approval.

The administration is pushing for the commercial sector to adopt this plan voluntarily and start installing the chip in all new hardware despite several serious questions: Why is this necessary? Why was the National Security Agency given the job of developing the Clipper algorithm? Why should the government be allowed to invade anyone's electronic privacy?

I urge everyone to write for further information to: The Electronic Frontier Foundation, 666 Pennsylvania Ave. S.E., #303, Washington, D.C. 20003.

Ryder Crockett
Honolulu, Hawaii

MARCH FOR FREEDOMS

It is time to make a stand! We have a government that, given the time, will take away the last vesti-

ges of freedom we have left. We have seen it through confiscatory taxes, universal health care, socialism taught in our public schools, federal mandates and controls, centralized banking and now they want to confiscate our guns. Make no mistake about it, if they accomplish this, our god-given gift of freedom will be but a memory.

I think it is imperative that we send this government a message: *Get out of my life!* Therefore, I urge everyone to attend the pro-gun

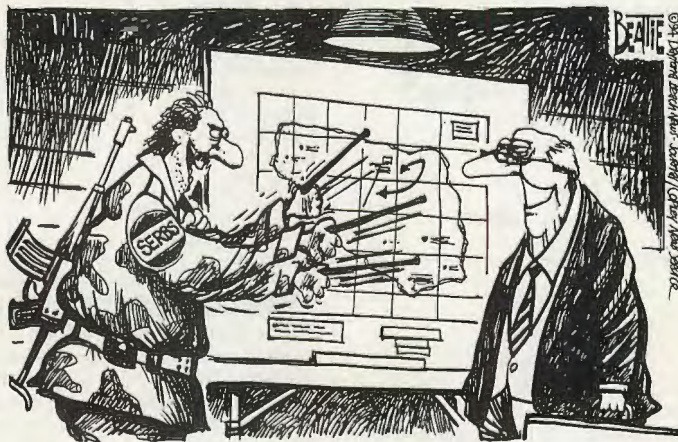

"Negotiate peace here, so we can attack here, here, and here!"

march scheduled for 3 July 1994 in Washington, D.C. I ask that you make this commitment for the sake of those you love and the freedom of all you hold dear. Write to Robert Paul Johnson, 1920 Wells Road, Powell, TN 37849, for information.

John C. Glasgow
Marietta, Georgia

AMERICAN LEGION WOULDN'T CUT AND RUN

It is not surprising that David Hackworth's articles drew letters like those printed from Rev. Rittenhouse and Master Sergeant Letteer ("FLAK" SOF March, April '94). Reverend, the press did not cause us to lose the war, and master sgt., we did lose it.

Hackworth's article on the need

for our own foreign legion is right on the money. He describes a force the nation could really use in this era of Americans' reluctance to fight for themselves.

A foreign legion incorporated into our military TO&E would help prevent a repeat of past tragedies. Look what happened to the foreigners who fought for us in Civilian Irregular Defense Group (CIDG) units in Vietnam and as our infantry during nearly 15 years of the "secret war" in Laos. We cut and ran, abandoning the various Montagnards in Vietnam and the H'mong in Laos after our defeat. *Betrayal* may be a more correct term than *abandonment* because they did not expect the CIA and U.S. Army Special Forces men — me included — who had been alongside leading/directing them in combat all those years, to suddenly flee. The appropriate comparison is of infantry officers running to the rear when their outfit is in mortal combat. The

victorious lowlanders — Lao and Vietnamese — took immediate and expected bloody vengeance on those we left behind.

The State Department's traditional unwillingness to be accountable for what it does to soldiers does not change. Telling the U.S. Congress that the H'mong refugees still in Thailand "...can go back to Laos [because] there never has been one verifiable story of anybody being persecuted for having been repatriated" maintains the Department's traditional high standard for hypocrisy. The U.S. mission in Laos makes no unescorted, unannounced visits more than 5 clicks from the national capital of Vientiane, hence can keep its pious hopes/beliefs unquestioned. Dr. Jane Hamilton-Merritt's book,

Professional Locksmithing Tools

LOCKAID

Specifically designed to pick tumbler locks. Designed over thirty years ago to aid law enforcement agencies. Consists of tension wrench, three needles and Lockaid "Gun." Prices include a copy of the book "Lock Picking Simplified."
Lockaid \$69.95



PIX MODEL 13

This deluxe yet compact kit features 11 of the most commonly used tools. Comes in a slim cowhide leather case for discreet undercover operatives. As a special bonus, a 5 piece set of **warded picks** is included. A 16 piece set total. Also included, a copy of "Lockpicking Simplified." Receive all this at a low price of:
Pix 13 \$42.95

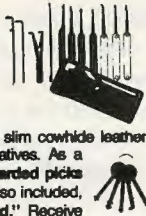

PXP 8

- Shirt Pocket Size.
- Top Grain Cowhide Leather.
- Has 8 Picks, Tension Wrenches and Broken Key Extractor.
- All Picks with Metal Handles.
- Copy of Lockpicking Simplified.

PXP 8 \$24.95

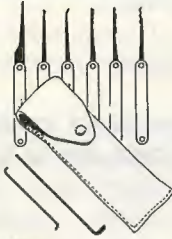

PXP 10

- Shirt Pocket Size.
- Top Grain Cowhide Leather.
- Has 13 Picks, Tension Wrenches and Broken Key Extractor.
- All Picks with Metal Handles.
- Copy of Lockpicking Simplified.

PXP 10 \$34.95



PIX-EZ All-In-One Pick-Set

100% American Made! As convenient to carry and use as a pocket knife! Only 4 inches long, half inch square, weighs under five ounces, works fast and opens pin and waster tumbler locks quickly, with very little effort. Six tempered spring steel picks, tension wrench.
\$34.95



WKS PICKS

Made of the finest blue tempered spring steel this 5 piece padlock pick-set is a must in every locksmith's tool box. This set will pick open most every warded padlock made today.
\$9.95



| | |
|-------------------------------|---------|
| Lockpicking Simplified | \$8.50 |
| Complete Guide to Lockpicking | \$15.00 |
| Improvised Lock Picks | \$9.95 |
| Tubular Locks | \$8.95 |
| Lockout and forced entry | \$8.95 |
| Involuntary Repression | \$10.95 |



| | |
|---------------------------|---------|
| Safe & Vault manipulation | \$9.95 |
| How to Pick Pins & Wafers | \$9.95 |
| Combination Locks | \$8.50 |
| Keys by Impressioning | \$7.00 |
| Key Casting Manual | \$8.95 |
| Locks, Picks, Clicks | \$10.00 |

NEW MONTHLY SPECIAL

RECEIVE A COMBINATION SET
 INCLUDES — 5 ITEMS

| | |
|------------------------------|---------|
| 1-MD-16 DELUXE SET | \$59.95 |
| 1-SCHALGE WAFER SET | \$27.95 |
| 1-SESAMEE DECODER | \$17.95 |
| 1-WKS PICKS | \$ 9.95 |
| 1-DOUBLE SIDED TUMBLER PICKS | \$27.95 |

A VALUE OF \$143.75
AT A LOW PRICE OF \$89.95



ESP-13

This handy new pick set is the most popular set among professional locksmiths today. This kit consists of 12 different tools housed in a handsome black leather case designed for a shirt pocket. Included in the price, you receive a 5 piece warded key set and a copy of "Lockpicking Simplified." 17 piece set total.
ESP-13 \$45.95



KEY RING PICK SET

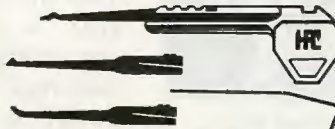

This unique design is ideal when low profile is required or to keep on your keyring for emergencies. Contains a tension wrench, three picks and the "Key Pick"
Key Ring Pick Set \$27.95



MD16

Shirt Pocket Size, Top Grain Cowhide Leather, Zippered Case, has 16 Picks, Tension Wrenches and Broken Key Extractor.
\$59.95



DOUBLE SIDED DISK TUMBLER PICKS

Set of 4 picks designed to be used on the most popular double-sided disc tumbler, showcase, cam and padlocks.
\$29.95

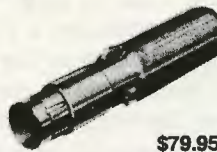

MINI PICK TUBULAR

The most effective tubular pick on the market, unlike the larger picks with long handles or screwdriver handles. The longer the tool, the more pressure needed which causes easy breakage. The advantage of the Mini Pick is it is so short, you only use your thumb and index finger. With a little practice this tool will open a tubular lock in less than a minute.
 A. Your Choice: (1) Center (2) Offset left (3) Offset right; B. "Segal" 8 pin tubular; C. 5-pin Tubular; D. 6-pin Tubular; E. 8-Pin Ace.
\$79.95

SESAMEE DECODER

This tool was designed to decode the exact combination of a sesame padlock without damaging the lock. Detailed instruction included.
\$17.95



SCHLAGE WAFER

The most fantastic tool you will ever use. This set consists of two base keys and pick. Complete instructions included.
\$29.95



MD32

Hip Pocket Size, Top Grain Cowhide Leather, Zippered Case, has 32 picks, Tension Wrenches, Broken Key Extractor.
\$69.95

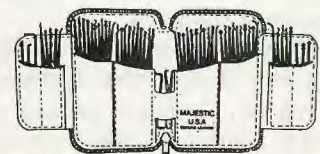
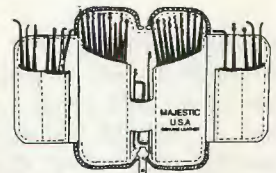

MD60

Top Grain Cowhide Leather, Zippered Case, has 60 picks, Tension Wrenches, Broken Key Extractor and Warded Master Keys.
\$99.95

Catalog \$3.00
 Free with order.
 Sorry, no credit card orders



The law requires all purchases be made in good faith, without make believe or fraud by genuine persons within this industry

Send to **Steve Arnolds Gun Room** postage & handling **\$5.00** Overseas Surface **\$6.00** Add 30% of total for overseas mail. Must be 18 years of age.

P.O. Box 68, Dept. SF07, Dexter, OR 97431; (503) 726-6360

Tragic Mountains, is the unvarnished truth about our secret war and an excellent rationale for forming a foreign legion.

Let us not let non-soldiers betray another legion. Let's recruit one, but do it right! Hackworth as the first commander? Or at least its godfather.

Carl F. Bernard
Alexandria, Virginia

QUESTIONABLE LOYALTY

I want to extend my congratulations and thanks to *SOF* for having the guts to print what we in the

but with the likes of liars like Paula Coughlin and Beth Warnick, I now distrust most women in the military and they have only themselves to blame.

Lt. Commander "Bitter"
Norfolk, Virginia

MAYAGUEZ OWNERS BLACKMAIL U.S.

Richard Harris' story about the *Mayaguez* incident deserved to be written as it's a tribute to the loyalty of the entire U.S. maritime establishment, civilian and military.

The shame, however, is that the

U.S. company that owns the *Mayaguez* and has benefited from the American public in both blood and treasure for many years, most recently with the tremendous profits from the Gulf War, is now attempting to blackmail the government into parting with even more money

and is threatening to reflag its vessels and hire foreign sailors if it doesn't get its way.

This company's true loyalty can only be found in the marketplace. Its machinations have frequently been the subject of civil suits, regulatory fines etc., yet it continues to exercise control of the U.S. government. Now that's a piece that really deserves to be written.

E. F. Riccio
Jamaica, New York

HELP SEND HCI TO PRISON

I just finished reading HCI's agenda and have only one question: Why haven't these criminals been prosecuted? Under federal law (Title 42, United States Code, section 1983, 1985, 1986 and/or USC sections 241 and 242), it is illegal for anyone under the color of law to deprive any citizen of the rights, privileges or immunities

secured by the U.S. Constitution. This is a felony crime punishable by up to 10 years in prison.

What HCI advocates is exactly such a deprivation of rights. Is it not criminal conspiracy to incite, aid and/or abet the commission of a felony? While I support the right of free speech, incitement to the commission of a felony crime has never been seen as protected speech.

It's not that there ought to be a law, there is a law — and there ought to be prosecution.

Steven Johnson
Knoxville, Tennessee

US, THEM AND THE IRS

This letter is in response to the article "Hardbreak Hotel" (*SOF* April '94). As a former IRS employee, it never ceases to amaze me the levels to which IRS agents stoop to deliberately screw up people's lives. Having worked with agents on numerous occasions, I can tell you from personal experience that they act like they're collecting money owed to them personally.

IRS supervisors will lie, cover-up and be blatantly deceitful to anyone who tries to question them. The only people who can get answers from the IRS are members of Congress.

Wake up, America! It is not the common criminal we need to worry about, it's government thugs with warrants based on lies. The IRS is not mentioned in the Constitution, but they have always circumvented the Constitution to fulfill their dastardly deeds.

Being a patriotic American can be dangerous because you will be labeled a radical, subversive troublemaker, and agencies like the IRS will make your life hell. It's time we again take control of our government; it's ours, not theirs — and there are many more of us than there are of them.

Name withheld on request

WRITE TO SOF

We invite reader comments: Send letters to *SOF*, c/o FLAK, P.O. Box 693, Boulder, CO 80306. Due to limited space we reserve the right to edit for content and brevity. ✕

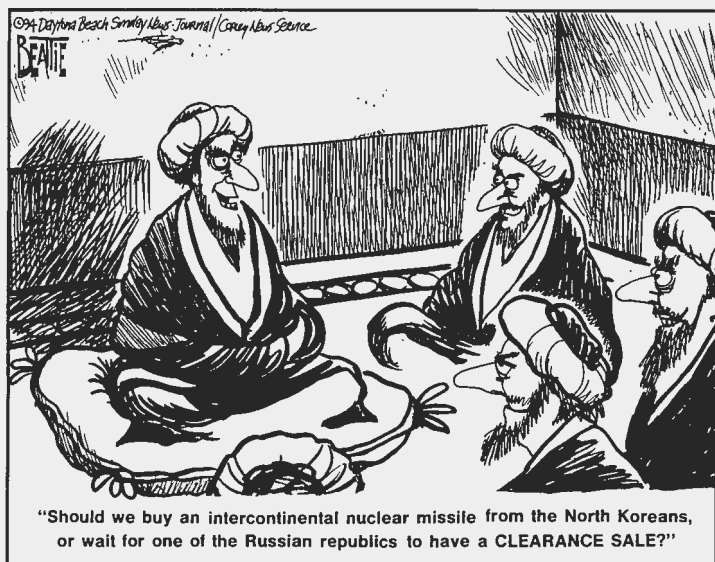

naval services have known for more than two years: that while plenty of male officers were out of line at Tailhook '91, so were many female officers. Yet, due to lack of morale courage by the powers-that-be, only charges against male officers in the Navy and Marine Corps were pursued.

I am not excusing any officer for acting like a drunken, lecherous idiot, nor am I trying to excuse any officer's inappropriate behavior. However, if we are going to hold male officers accountable for indecent exposure, public drunkenness and lewd behavior, then female officers who participated in the same conduct should likewise be held accountable.

This old salt used to trust women in the naval service and used to argue on their behalf. Now I am starting to see them as a special interest group with questionable loyalty. I was once a supporter,

“And, of course, the most amazing thing is how *fast* you can learn it!”

Top Secret Hand-To-Hand Fighting System Finally Released To Limited Number Of Civilians!

Now, with the sudden release of this incredible elite military fighting system, you can easily “take down” trained boxers, Karate black belt masters and street thugs twice your size... *even if you’ve never been in a real fight before in your life!*

— by Dr. R. L. Horine —

Dear Friend,

A year ago I would have *never* written you this letter. You see, I’ve gotten on the “inside” with some of the most dangerous soldiers and law enforcement people on the planet (including members of the Navy SEALs and combat instructors for the DEA, Army Rangers, major police department SWAT teams and others.)...

We all shared the same arrogant attitude: This new “simplified” hand-to-hand fighting system created for combat and intense criminal warfare should *not* be released to the general public. Because...

It’s Just Too Dangerous To Be Allowed To Fall Into The Wrong Hands!

I initially felt the same. But I’ve recently changed my mind in a big way... all because of a beautiful woman named Julie. I’m ashamed that I withheld these important street-fighting skills from people like her — good people (like you, too), who are *unnecessarily* walking the streets as living targets for the criminal scum who prey on innocent victims and just love to humiliate and ruin people’s lives.

Here’s what happened: Julie was assaulted and badly beaten, by a man she could have easily knocked unconscious and escaped from — if only I had taken **15 minutes** to teach her what to do! It doesn’t matter that she’s a petite and gentle woman. The few simple skills of this new fighting system can be taught to *anyone* in an almost unbelievable short time, because it requires no strength, no agility, no special talents, no speed, *no nothing!* Forget what you see on T.V. — the most effective fighters in the world never use spinning head kicks or elaborate punches... in fact, they never “punch” at all. It’s all so much more **simple** than that — I’ve seen 60-year-old grandfathers and 13-year-old teenagers *master* this stuff almost overnight. For people like *you*, well, it’s even easier.

Julie knows how to defeat 99% of all street thugs **now**... but she was taught just a little too late to avoid those emotional scars she’ll have to live with for the rest of her life. And now, in all honesty, I’m doing my damned best to make

sure every “good guy” I can reach *never* has to go through what this lovely lady did...

And I Don’t Care What The Military, Or Anyone Else, Says!

Here’s the bottom line: How safe do you feel in today’s jungle-world? Are you even remotely interested in learning how (in a matter of mere hours) to turn any attacker or bully into a pile of bleeding beef at your feet — and so *automatically* — that you (or your loved ones) can always *terminate a dangerous physical assault situation before it even begins?* Would you like to have the confidence to walk nearly any street in the world, any time of day or night... knowing without question you can “neutralize” the threat of physical assault by criminal scum as easily and thoughtlessly as you would shoo away an alley cat?

I guarantee that if you are like every other man I’ve talked with in the last year, just *reading* this short message you have in your hands will start amazing changes to happen in your life! Changes that will turn you into a true modern-day warrior...

With So Much New Confidence Leaking From Your Pores People Will Take Notice From Across The Room!

I don’t care if you’re in the worst physical shape of your life, or even if you’ve never hit another person before, or don’t have the coordination to walk and chew gum.

Julie learned it... *and* a thousand guys smaller and weaker than you have learned it, too. Almost *overnight*. A Navy SEAL combat instructor told us that this fighting system can turn *anyone* into a potent hand-to-hand fighter. He said it’s amazingly easy to learn, easy to remember, and best of all, easy to *use* when needed!

Are you skeptical? Good. That means you’re not gullible, not easily fooled. But then almost everyone I’ve met in the last year has been just as skeptical as you. And listen to what happened:

—A pint-sized writer I know from Los Angeles was nursing a broken rib when he was bear-hugged from behind by a construction worker bully who outweighed him by at least thirty pounds. Now, this writer had never been

in a real fight before in his life... in fact, his only training came from just *watching* the 8 basic moves of this fighting system on video tape... one time! Yet he automatically used one of those “moves” the second he felt his rib begin to give...

And Was Astonished To Turn Around And See His Attacker Down And Whimpering On The Sidewalk!

—A fairly well-known West Coast bodybuilder and ex-college middle linebacker named **Bob Pierce** (6 foot 4, 240 pounds of raw muscle), who also had studied Judo for 4 years, absolutely did *not* believe that a little guy like me (5’6”, *maybe* 170 lbs. soaking wet) could “put him down” *if he surprised me from behind!* Well, I did... and he’s still tender where I “controlled” him with the simplest little move — and damn lucky I decided not to teach him a *real* lesson about going after smaller guys!

—A working mother named **Cindy Bowes** from Ohio... after *glancing* at this stuff (on a video), could only remember **one move** when she was assaulted by a man on her front lawn — but that one move put her assailant into such a boggled state that she was able to leisurely call the police and have him hauled off.

Here’s how this amazing fighting system “leaked” from the most elite military circles into your hands: You’ve never heard about **Paul Vunak**, but the SEALs, FBI, CIA and a dozen police department SWAT teams have. He is without question one of the most respected — and *dangerous* — men in the world at hand-to-hand combat — teaching it, and using it. For over 20 years he’s been mixing it up with every sort of fighting “expert” you can imagine... on the street, “in the clutch”, and in thousands of situations where his life was absolutely on the line.

The U.S. Navy SEALs brought Paul in to teach them his unique system after an exhaustive worldwide search for the *best* hand-to-hand combat system in existence. Paul didn’t ask them, mind you... **they asked him**. That’s how serious Paul’s reputation is in the world of real-life warfare. The SEALs, you probably know, are flat-out the most deadly-efficient soldiers on the planet. They

won't even *consider* a fighting system — especially a hand-to-hand one — unless it can be taught quickly and used with **100% effectiveness, 100% of the time.**

These Professional Soldiers Know If Their Training Fails, They Will Die In Combat!

That's why the **SEALS** love Paul's system. It incorporates real-life fighting tools no other system has; yet it can be mastered in an astonishingly short time. These soldiers have to spend most of their training time getting in shape, learning complex weapons, and studying top secret military operations. They simply do not have the time to bang around in dojos learning complicated martial arts like karate or Tae Kwan do.

In fact, if you talk to a **SEAL** about martial arts, he'll *laugh* at you. They know it can take *10 years* to become a black belt in any given discipline... and even then, your average YMCA-trained boxer will still dismantle your ass in about 10 seconds!

Most of these super-elite soldiers have black belts in a martial art (sometimes three or four)... but they don't even *consider* using any of it. All that fancy kicking and hacking may look scary, but it doesn't work on the battle field... or in the street.

It simply doesn't work.

Imagine this: You're a **SEAL** out in the action; you've just crawled through miles of dense jungle, you haven't eaten for three days, you're dehydrated, sick from dysentery, wounded in two places, out of ammo, and carrying a sixty-pound pack.

You *ain't* gonna rely on a Hollywood spinning round-house kick when the enemy ambushes you. That's not the way real fighting happens. And that's why Paul Vunak's "simplified" hand-to-hand system is so treasured by the soldiers and police and federal agents who need to *rely* on it.

* **There are no complicated moves!** In fact, in Paul's "basic" system, there are *only 8 moves total!* And all of them are unbelievably effective, and all can be learned and *mastered* in only a matter of hours.

* **You don't have to be quick, or coordinated, or even in decent physical shape!** All the deadly power comes from extensions of the way your body *naturally* moves. This is called your "gross motor skills" — the same simple movements you use to walk across the room, to scratch your ear, or to step into a car. (I've seen 5-year-old kids who still run funny take down bullies twice their size and age... and little old ladies with limps cancel out young violent men!)

* **You don't need to train constantly to become a master of this system!** The **SEALS**, the cops, the agents... *none* of them have time to waste in training. Yet they feel confident using Paul's system even after a *single lesson!* (As you will, too!)

* **Plus, just as importantly, there is no formality, no religious nonsense or bowing or wearing odd uniforms in this system!** It is *not* martial arts — it is a simplified fighting system that goes *beyond* the street-smarts any martial art could ever offer you!

So how did Paul come up with this amazing fighting system? First of all, he's very well-known in the martial art field. He studied with the legendary **Dan Ionsanto** — original partner of martial art film star **Bruce Lee** ("Enter The Dragon") in the art of Jeet Kune Do. You probably haven't heard of this strange fighting art, but nearly every karate magazine devotes dozens of pages to it. It isn't really an ancient art in itself, like Kenpo or Kung Fu — instead, this Jeet Kune Do is sort of a "greatest hits" method of all the best parts of *all* the martial arts. Bruce and Dan and Paul have been copied (mostly unsuccessfully) by thousands of "wannabe" martial art experts. Yet only Paul "walks the walk" of a true seasoned street-fighter, and is absolutely *idolized* by the "karate crowd" for his warrior life-style.

Paul — who is the internationally-acknowledged master of Jeet Kune Do, and considered the man who went on where the more famous Bruce Lee left off — had *only one rule* when choosing the moves he would incorporate into his "simplified" hand-to-hand system:

It Had To Work 100% Of The Time In Actual Street Fights... Where There Are No Rules!

Paul has proved, over and over again with his own blood (and life) on the line, that his basic system can help anyone defeat even the most brutal, huge and insane street fighter in hand-to-hand combat.

It's not a game to Paul. It's not a game for the soldiers and cops who have to use his system to save their lives. And it won't be a game for you, once you've seen for yourself how easily you can incorporate this amazing system into your own life.

Listen: In spite of his efficiency at fighting, Paul Vunak is one of the most compassionate men I've ever met. And he absolutely agrees with me that it's a crime so many good people are walking around afraid in their own neighborhoods — afraid of being attacked, afraid that their girlfriends or wives and kids will be assaulted, or kidnapped, or worse. Paul has a lot of people close to him; he knows what it's like to fear for the safety of loved ones.

That's why he has volunteered to bring his basic fighting system to the public. You should know that he is taking an *enormous risk* in doing this — his job with the Navy **SEALS** is important to him... and the military has a long history of being *very angry* with people who share their secrets.

But Paul doesn't care about that. He knows his simplified system will absolutely mean the difference between life and death for a lot of

people who need it — people, like you...

Who Still Remember When A Civilized Man Was Responsible For His Own Safety!

Paul has just one serious request. He wants every precaution taken to keep this important fighting system out of the hands of felons and "suspicious" types. And that's my job — that's why I'm being almost overly-paranoid about who I let see this stuff. As much as is humanly possible, I intend to keep this away from the criminals out there... while at the same time giving the advantages this system offers to as many of the "good" people as I can reach.

I don't know how long I will be allowed to offer Paul's system, either. Just last year, the U.S. military clamped down hard on someone else who was trying to teach civilians some of their "inside" combat secrets. It's a judgement call on my end — but, like I said...

I Don't Want Any More "Good Guys" Hurt Because They Didn't Have Any Of These Simple Street Fighting Skills!

At first we were planning to go from city to city doing seminars, spreading a slow wake of confidence among people as we traveled. But that would take too long, and in the end we still wouldn't reach everyone who needs this crucial survival information. No — we had to find a way to get this stuff into the hands of every deserving person *as quickly as we could.*

What we did was, I think, brilliant. We decided to *video-tape* an entire "teaching course" with Paul, and get it to a pre-selected number of people through the mail, all at once. Believe me, this is no ordinary video — instead, it's a genuine **breakthrough** in training technique... even better than what many of the cops and soldiers got during their own initial training!

Here's what you get: Paul Vunak went into a San Diego film studio for a week and allowed us to produce the most incredible video package you've ever seen. We were able to take that week's worth of shooting and "distill" it down to just *one* video — that's how simple Paul's system is. This single video is all you'll need to be able to learn (and master) his entire basic "simplified" hand-to-hand street fighting system!

This is the most intense and enlightening hour you'll spend in front of a T.V.! We spent months of preparation for the shoot, and spent about ten times more money in production than we'd planned on — but we're not complaining. This video surpasses all of our wildest dreams. You see, we've all seen about a thousand of the *other* videos out there — you can pick up any martial art *magazine* and see twenty ads a month for the latest fad among karate "experts". But they're all a huge waste of time, shot with "Uncle Ernie's" hand-held camcorder and without a second thought given to **teaching** you anything. All you get is a long, boring home video of a guy showing off his

air punches and spinning kicks, or of some weird seminar where you had to *be there* to get anything of value.

We went the *other* way — using 3 cameras on Paul and the action at all times. So you get the *best* shot to see what's happening, then get it again from a different angle... and then get it *again* in slow motion, with everything described and broken down into its simplest and most easily-learned form.

The way we shot this video...

You Might As Well Be In The Same Room With Paul, Getting "Inside" Advice And A Dissection Of Moves Most Soldiers Never See During Training!

Paul has absolutely dedicated himself to teaching you *everything* you need to know... and to do it so you can come away from your **first viewing** with enough powerful know-how and new skills to increase your naturally fighting ability by 200%... instantly! This is the equivalent of having 8 personal, super-intense lessons all recorded just for you... by the most *respected* hand-to-hand fighter on the planet!

Even better, Paul took the time to show you clear (and exciting) **real-life examples** of how to handle situations in a crowded bar, in a recreation room, and in the street. These "extra" situational learning tools remove any doubt you may have as to how to use your new skill in the real world.

→ You'll learn how to handle two attackers at once — with a one-two natural him-to-him-back-to-him-and-out of danger move that allows your body to act the way it *naturally* wants to.

→ You'll learn the difference between easily-applied "shock" moves, which set up an attacker for you to finish off when you choose to, and even-simpler "clincher" moves — the ones that will *instantly* end any fight the second you deliver them.

→ You'll learn exactly why the "joint manipulation" and difficult kicks of most martial arts don't work in real life situations — and why, once you know the simple moves of instantly ending a fight anyway, you don't even *need* to know anything else! (A veteran cop once told me how sad it always is to see the rookies fresh out of the academy try to use their fancy karate moves on a drug-crazed maniac or a drunk bully — only to get their heads cracked open while the criminal gets away, laughing. That's why the veteran is so happy he learned the **real** way to end any fight from Paul.)

And, of course, you'll also learn the main secret of this system's popularity with professional soldiers: it's easily learned, easily remembered, and most importantly, easily *used*.

Here's what else you'll discover in this amazing video:

* The single most important move you can make in any altercation — it's what your body *wants* to do, but what *most* people

panic about and refuse to allow themselves to do! (Yet it will save your life!)

* **How to use a simple "cat-like" move to instantly position yourself to deliver the easiest knock-out blow imaginable — a strike so natural your grandmother could pull it off against Mike Tyson!**

* **How to instantly "shut down" an attacker's testosterone levels, using your body's own built-in "brick". (Even a 90 lb. woman possesses this amazing rock-hard weapon!)**

* **Why hitting anyone with your fist is silly (even trained boxers bust knuckles that way)... and how to use the 8 "natural weapons" of your body to deliver 5 times the power of a fist with *half* the risk of injuring yourself!**

* **When to use the most *simple* strike you'll ever learn... an unstoppable natural move so effective in ending fights that it's not allowed in full-contact karate tournaments! (Instant disqualification — it's also a move that 99% of the most brutal street fighters you'll ever encounter have **never seen before... and don't know how to defend against!**)**

* **How to use the "hip-swinging secret" soldiers use to drop opponents instantly — no speed or strength required, yet it's like driving a 160 lb. bar of lead into the bad guy's belly! (It's so effective, you don't even have to come close to hitting your "target" area... even the sloppiest attempt by you will bring him to his knees!)**

* **How to effortlessly "parlay" the same natural force that has ended more professional football players careers than any other... it's a human's weakest point during a fight (or before a fight begins), and once you know about it you've just increased your ability to defeat a larger man by 200%!**

* **How to use a super-effective, completely unexpected technique straight out of the "Three Stooges" to cause any attacker to automatically (1) back up, (2) raise his hands in defense, and (3) blink rapidly... all of which *instantaneously reverses* the tables and makes your attacker suddenly vulnerable to a fight-ending blow you can deliver in your own sweet time.**

* **Why all elite soldiers are given "permission" to use the one street fighter's Secret Weapon we are all taught from kindergarten *not* to use... and how you can use it to quickly remove yourself from any situation where you have been surprised from behind!**

* **How to use the *other* "dirty" street-fighting tool not allowed in any civilized boxing or karate match... because of its immediate ability to disorientate and topple your opponent! (It *also* works when you do it incorrectly!)**

And more! Don't let the idea that a system with "only" 8 basic moves must be too simple to work, either — this isn't theory, this is the result of a lifetime of experimentation in blood! Everything Paul teaches you was perfected

either in the street, or on the battlefield... where it had to work, or good men would die.

Listen to what these experts have to say:

"There's no flare, no garbage, no ceremonial nonsense, no magic. Paul can spend 15 minutes with anyone and make you twice the fighter you were before!" — Shane Brott, Black Belt Martial Arts Instructor

"Finally, after 23 years of karate and other martial art styles (including military training), I found a system that works in the real world! Paul, where were you 20 years ago?" — Paul Iwamoto, Chicago

"Thanks for a video that the ordinary person who works for a living can actually learn from! I am passing these simple and effective tools along to my wife and children." — Rick Manente, Los Angeles

"Street Safe is the most effective self defense system I have ever come across." — CA Narcotics Task Force Commander, (Name withheld due to security regulations.)

"This (Street Safe) will probably turn the Martial Arts community on its ear... BRAVO Paul." — Jim Hinesly, SWAT Team Member, Hostage Negotiator, and member of Sheriff's Tactical Team.

Actual SEAL team members are not allowed (by strict Navy regulations) to comment, but in private conversations with me they have said that Paul Vunak's training system has provided them with the most realistic training they've ever had, going back 20 years!

"Paul has one advantage nobody else has — actual experience in street fighting. Having been in it, he can teach you how to not only survive, but win, even if you aren't experienced in the street." — Rich Chen, Hawaiian ex-street-fighter

"Listen: Any citizen who leaves the safety of themselves or their family in the hands of any organization, including your local police department, is in for trouble! We all need to take responsibility for our own well being. I feel this video tape will give anybody who watches it immediate tools in self-defense principles that will make you confident. And anyone from the age of 13 to 80 can use these tools!" — Sgt. Carlos Hernandez, South Florida Police Tactics Instructor

That last quote sure puts things in perspective, doesn't it? That's a police officer talking — telling you the days of relying on your local cops for protection are long gone!

Let me tell you something you already know in your heart...

As A Man, It's More Important Than Ever Before To Know How To Defend Yourself!

And, when your family and loved ones are at risk, you need to know how to take out

aggressors with **absolute certainty**. Watching Sly Stallone and John Wayne deliver movie-magic roundhouse punches doesn't cut it.

You have a **duty**, as a man, to protect yourself and loved ones *like* a man. And no amount of philosophical nonsense is ever going to change that fact.

You've seen the headlines — rape is up, assault and murder doesn't even make the front page anymore, and robbers are shooting people even **after** they give up their watches and money (it's a trend the police call "Thrill Killing"). Heck, there are jerks hurting people without *any reason at all!* The rules are gone. You could be attacked inside your home, in the back aisles of a supermarket or theater, waiting in your car at a light, anywhere, anytime, by a growing mob of remorseless scum who *enjoy* demolishing innocent people's health and lives.

But they aren't going to enjoy coming up on *you*, friend. Not anymore.

It's Time To Stop Being A Victim, And Learn To Walk Your Streets With Confidence!

Look, I know you don't want to turn into some hardened, mean-eyed killer. That's not what Paul's video is about. But do not doubt that the newfound confidence this information gives you will "leak" into every area of your life. I've seen it happen a thousand times...

- ◆ You'll "carry" yourself in a new way that just says "Don't mess with this guy."
- ◆ People will be extremely pleased to see you smile and be nice to them... and will go far out of their way to be extra nice to *you*, automatically.
- ◆ Have you ever seen how people treat a man like Sean Connery or Joe Montana when they enter a room? It's not just that they're good-looking... more, it's that these men *reek* of confidence and the lack of fear. You can have that, too.
- ◆ Plus, it has to be mentioned: There's an undeniable *sexual attractiveness* to any man who knows how to look the world in the

eye and not flinch. You can't fake it — it's a primal, animal part of us, and when it's there it shines like a searchlight in your eyes.

Now, let's be straight about something here: This is not a magic potion you take to become invulnerable. Use this system only at your own risk, and take responsibility all the way down the line for your actions. You can understand why I have to tell you this — we've gone to an enormous amount of trouble and risk to bring this material to you. We're not talking about playing games here; this is real life. Used correctly, Paul's basic system is without doubt your best first-line defense in a tight spot. You'll be able to "parlay" your learning into a few simple moves that will take down a man twice your size, even as he's assaulting you — and even if he has 10 years of martial arts experience, or a lifetime of street-fighting under his belt! This stuff is that effective.

But it's not fool-proof. Don't be a fool, and for God's sake don't go looking for trouble. That's not what this video is about.

That said, you should know that you will take **absolutely no financial risk** in ordering this video! It could not be simpler for you to get this video, watch it at your leisure, and decide in your own sweet time whether it's everything we have told you it is. In fact, you get an almost ridiculously-generous...

100% No-Questions-Asked Money-Back Guarantee!

If you aren't convinced, after owning this video for **3 entire months**, that it's the real thing, just send it back to us for a complete refund of your purchase price. You'll get no hassle from me or anyone else... in fact, I will *personally* make sure you are sent your refund by return mail. Heck, you don't even *need* a reason to send it back — I trust your judgement. Like I said, I'm just trying to get this info into the hands of as many "good guys" as I can... *while I can*.

Here's how to order: We've set up a special phone line for you — all you need to do is call **1-800-899-8153** and tell the person who answers you want the "Street Safe Code 5-X"

video package, and use your credit card. That's a toll-free call, and won't cost you a cent. Or, you can fill out the special Order Form below and mail it with your check to:

**Tactical Response Solutions
2945 S. Mooney Blvd. Dept. 5-X
Visalia, CA 93277**

That's all there is to it — and when you use your special "code", your video will be *shipped out by return mail!* The price for this video is dirt-cheap, too — in fact, at just \$37 plus \$2 shipping and handling (total: \$39), it's **less** than you'd pay for *one* lousy personal lesson in most karate schools... where at *most* you'd learn how to bow and assume some silly stance that will fool no one!

This really *is* a great offer — because it's the real thing, because your life will change immediately for the better... and because you risk *nothing* by giving the video a "test run" on your own T.V. set.

Don't put this off — *remember, there's a very real and very serious chance this information won't be allowed out to the public for very long!* And if you don't order right away, you may never see this offer again, ever. Don't let that happen — you stand to lose *nothing*, and yet what you can **gain** is more important to living well in this world than *any* other skill you'll ever learn!

Sincerely,



R. L. Horine
President, T.R.S.

P.S. One thing — It's *very* important. I have a few copies here of a hot new special report, and I want to send it to you, absolutely **FREE**. It's called *Close Quarters Gun Disarmament*, and it's written by Randy Wanner, chief instructor at a national institute that *exclusively* teaches FBI, DEA, SWAT and other specialized units... but never civilians! In fact, **this report was never intended for civilian eyes** — Randy has only agreed to let me give this to carefully selected people who have been cleared to receive our *Street Safe* video.

The information in this hot report has **already saved the lives of officers on duty** — it's a revolutionary technique that allows you a 91% chance of disarming an assailant without getting shot... and with the increase in armed robbery in the U.S., *where people are shot even when they cooperate*, this report could absolutely save your life.

It's yours **FREE** when you get the video... and you can **KEEP** it even if you decide later to return the video package!

[WARNING: This is **NOT** the disarmament technique currently being taught by some horribly misinformed "experts" out there — *any* technique you see *advertised* for the public has **not** been cleared by the institute, and is *dangerously* ineffective! No matter what you do, please do **not** take advice from "experts" with no experience in real-life armed situations!]

For The Fastest Service Use Your Credit Card And Call Toll-FREE

1-800-899-8153 (Ask For Department 5-X)

PRIORITY ORDER FORM FOR Soldier of Fortune READERS ONLY!

YES! I want to take advantage of this incredible opportunity while it's still available... I'm ready to take responsibility for my own safety and the safety of my family! I understand I have an overly-generous 3-Month No Questions Asked 100% Guarantee: If after viewing this video for three months, I am unsatisfied for any reason at all, I can simply return it for a full refund of my purchase price. That means I can decide for myself if this really is the most amazing self-defense self-taught course ever created. It's a fabulous deal, and I don't risk a dime by ordering! So please, rush it to me by return mail!

→ _____ By initialing this line, I am stating that I am over 18 years of age and that I have never been convicted of a felony. I also state that I will use the information contained in *Street Safe* in a defensive situation only. I accept sole responsibility for my actions as an adult.

I prefer to pay by credit card. Please charge my:
 Visa MasterCard American Express Discover

Enclosed is my check (payable to TRS), for \$39.
Please rush my *Street Safe* video to:

Card #: _____

Name: _____

Expires: _____

Address: _____

Signature _____

City: _____ ST: _____ Zip: _____

Tactical Response Solutions • 2945 S. Mooney Blvd. Dept. 5-X • Visalia, CA 93277
CA & VA residents add appropriate sales tax. Rush shipping available for additional charges of \$10 for "2-Day" shipping and \$15 for "Overnight" shipping.

Salute to D-Day Vets

**“Never in the field of human conflict
was so much owed by so many to so few.”**

— Winston S. Churchill

Churchill’s words to fighter pilots during the Battle of Britain would take on new meaning four years later when Allied forces conducted the largest amphibious invasion in history. Robert K. Brown and the staff of *Soldier Of Fortune* take the occasion of the 50th anniversary of Operation Overlord to pay tribute to the veterans of WWII, and offer our eternal gratitude for their sacrifice and valor.



Photos: AP/Wide World

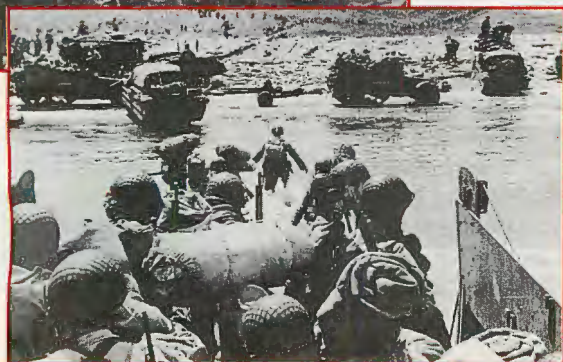

Top Left: “You are about to embark upon a great crusade ... good luck! And let us all beseech the blessing of almighty God upon this great and noble undertaking.” — Gen. Dwight D. Eisenhower. Photo: National Archives

Top Middle: American assault forces approach Normandy beachhead. Though they cannot see over the protective bow door, they know what lies ahead: the liberation of Europe. Top Right: Even in the heat of battle, the soldier’s creed “hurry up and wait,” applies. On Utah Beach, troops take cover behind a sea wall, waiting for the word to go.

Left: “Wars may be fought with weapons, but they are won by men. It is the spirit of the men who follow and of the man who leads that gains victory.” Gen. George S. Patton’s words in 1933 were borne out in 1944.

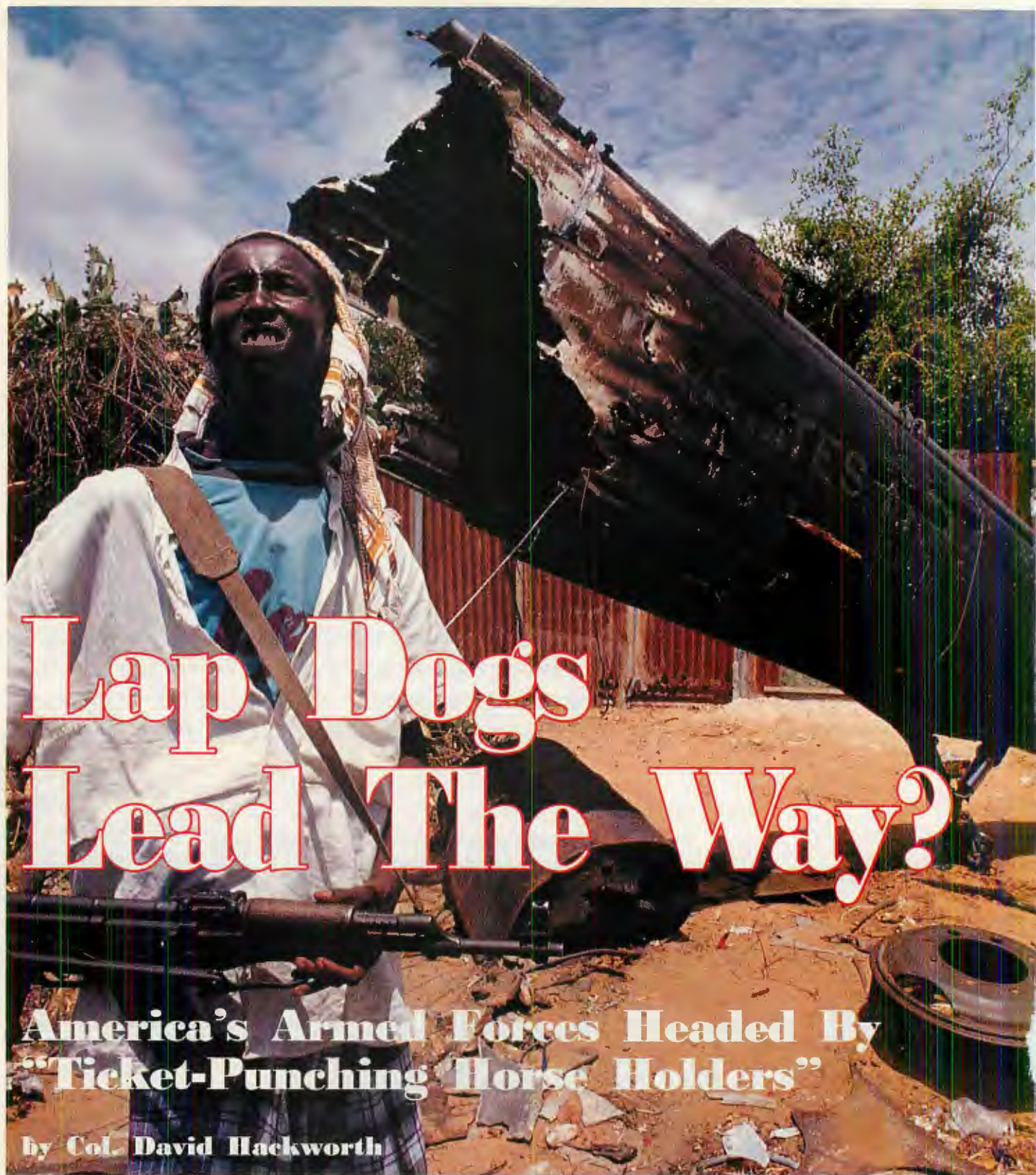

Lap Dogs Lead The Way?

**America's Armed Forces Headed By
"Ticket-Punching Horse Holders"**

by Col. David Hackworth

Photo: SOLO

Had stand-up-and-be-counted, tactically competent warriors been running the show in Somalia, the dangerous daylight helicopter raid into Aidid's urban stronghold that killed 18 Americans would not have been a go. An experienced war-fighter would have said the risk of such a raid was not worth

the gain and stressed that in irregular fighting, patience is more important than boldness.

But war-fighters are becoming an increasingly scarce breed among the flag ranks. One rare exception, a serving warrior general — I'll call him General Truth — looked at the most recent Army promotion list to

brigadier general and said of the 38 nominees: "Only three are fighters. The rest are ticket-punching horse holders."

General Truth's comments track with a 1989 survey of U.S. Army officers that concluded soldiers at the bottom believed many of their top leaders were the wrong guys to run



America's military machine. These findings jibe with a 1984 study that found "The bold, original, creative officer cannot survive in today's Army." This report concluded, "The officer corps is focused on personal gain rather than selflessness."

Recent events reveal that the troops are, as usual, dead on target and

strongly suggest the promotion system to the top grades in all services is seriously flawed:

- Thirty-three admirals and generals were recently punished for their lack of leadership during the Tailhook scandal.

- A Marine Corps two-star general was found guilty of falsifying his flight records and given his walking papers.

- An Army two-star general was "zippered out" (read fired) for hitting on his female driver.

- Two Air Force generals and a full colonel were found guilty of juggling the books concerning a new aircraft, to the tune of \$1.5 billion.

- A Navy three-star admiral, who was responsible for the Navy's code of ethics, was punished for covering up for a homosexual sailor on his staff who hit on another sailor.

- A Navy four-star admiral lied about the location of the USS *Vincennes* which shot down an Iranian jetliner while in Iranian waters during the Gulf Crisis.

- An Air Force four-star general lied to the defense secretary about the Stealth fighter's performance during the invasion of Panama.

- According to an Air Force IG report, Lieutenant General Buster Glossan "lied under oath" concerning his effort to tamper with the outcome of an Air Force general officer pro-

source in the Pentagon's Office of the Inspector General.

All of these cases have been covered up. The guilty get their walking papers and a fat retirement check as in the case of Air Force Gen. Edward Barry, who was fired by Les Aspin "for his involvement in a scheme to make illegal or improper progress payments on the C-17 [a much-troubled transport plane]" to the tune of \$1.5 billion. The ever-defiant and devious Air Force top brass not only tried to cover it up, but even promoted him to three-star "after engaging in the alleged misconduct reported by the DOD IG." I suppose this was a little, "Thank-you-for-doing-a-good-job-stealing-from-the-taxpayer" bonus.

Eight-Alarm Character Fire

What we are looking at isn't smoke from a small brush fire; it's an eight-alarm character fire burning up the top people responsible for the security of the United States. I believe as did Bernard Baruch, a close adviser to FDR, when he said, "I have witnessed a whole succession of technological revolutions, but none of them has done away with the need for character in the individual ..."

So many cases of corruption at the top tells me that many senior officers' real character traits are missed by the promotion boards and Congress, caus-

"The Rangers belonged to Montgomery before the crap hit the fan, but afterward, there were new fall guys. It's the old story of fast shuffling and damage control. With ticket-punchers, no one is responsible and no one is accountable." Wreckage of one of two choppers shot down during Ranger raid on Olympic Hotel in Somalia.

motion board.

- A Navy four-star was accused by the Tailhook judge of lying under oath and manipulating the investigation to "shield his personal involvement in Tailhook '91."

If these honor violations were not enough, during the past four years there have been more than three dozen additional cases in which the conduct of serving admirals and generals resulted in demotion, reprimand or sacking for charges ranging from misappropriation and submitting false reports to conduct unbecoming an officer, according to a "Deep Throat"

ing the wrong guys to get the stars. Promotion boards can be fooled and manipulated, but grunts are not so easily fooled. They can tell in the time it takes to squeeze a trigger if a leader is good or bad, selfless or self-serving. They can spot a boss whose loyalty is to those at the top or those at the bottom as quickly as they can slam in a fresh magazine.

Grunts tell me the straight-shooting, stand-up-and-be-counted fighting leaders the profession of arms demands are only rarely making it to the top these days. Ticket-punching — a cancer-like character zipper — has

been chronic for years and the post-Cold War drawdown has zoomed it up to epidemic levels.

The maze officers must scurry through to get to the top became an institutional way of life in the military after WWII. The first punch on an Army officer's career ticket begins when, as a second lieutenant, he completes basic training/parachute school and ends three and a half decades later with the punch of Chairman of the Joint Chiefs of Staff.

Each punch, be it a command, staff assignment, "elite" school or colored piece of ribbon, must be perfect. Excellence is imperative. Mistakes mean sudden burnout to a shooting star. To err is a sin that has made covering up, ducking and weaving, and letting

Photo: AP/Wide World



"A Navy four-star admiral lied about the location of the USS *Vincennes* which shot down an Iranian jetliner while in Iranian waters during the Gulf Crisis." Iranians shout "Death to America" after the downing.

someone else hang out to dry a way of life in today's armed forces.

Few officers stay in one job long enough to really learn it. It's hurry through the maze to the next punch. Do this for a decade or two, and the runner becomes a shallow jack-of-all-trades and master of none. To make it, the gung-ho captains and majors must become actors who wear a go-along-to-get-along mask. By the time they're wearing stars, many have lost their ability to be true to themselves or anybody else. They have lost their identity. They have become the mask, rather than a caring/competent person.

The Slick And Quick

In most cases ticket-punching becomes second nature and character — the dominant and indispensable factor in leadership — becomes mutated

beyond repair. It's a system that virtually dooms the tells-it-like-it-is leader and accelerates the smoothies to the top of the ladder. The slick and quick make it and the James Gavin-like (inspirational WWII commander of the 82nd Airborne Division) warriors perish or become housebroken lap dogs, like their masters, who can only nod their heads in agreement to their superiors' often-flawed ideas.

Several years ago, Dave Hunt, a tiger of an infantry battalion commander in the 2nd Infantry Division was told by his CG, Gen. Jack Woddal, that during the previous two years he was the best battalion commander in the division and the best CO he'd ever seen. But, on the down side, the general said, "I'm not recommending you for brigade command [the next and one of the most critical punches for a combat arms officer to get a star]. You're not general officer material. You're too abrasive and you wouldn't mix well with the lawmakers on the hill" — meaning he wouldn't lie and pump up worthless hardware the Army wanted because it brought in precious defense dollars. And being a "couthless war-fighter," he probably wouldn't know which fork to use at some congressional social outing. This potential Ulysses S. Grant's career was as dead as if he'd shown up naked at a tea party and then spit a wad of tobacco juice into the bellybutton of the CG's wife.

Fortunately for America, Sen. Sam Nunn heard about Hunt's case and got this fighting soldier's career back on track. He is now a serving full colonel and one of the best war-fighters I've known — and there are other great warriors out there. I could name several dozen Army guys (the service with which I am most familiar): leaders such as Carmen Cavaza, Jack Keane, Steve Arnold, Glenn Marsh, Bob Foley and Hugh Shelton; but sadly they are in the minority. From the looks of the latest Army promotion list mentioned by Gen. Truth, the "Perfumed Princes" will retain the upper hand.

Perhaps it's always been this way. When President Lincoln appointed Grant as commander of his defeated army, a proper Perfumed Prince (along

the lines of Al Haig or Bernard Rogers) sniffed that Grant was a drunk. Lincoln fired back, "Find out what he drinks and send all my generals a case."

Grant wasn't the first renegade general to save our nation. This has been a common scenario since the beginning of our republic and it's only gotten worse as we have lurched into the 20th century.

Perfumed Princes

At the beginning of WWII, when the Perfumed Princes were in charge, disaster followed disaster — from Pearl Harbor to Kasserine Pass. Then the smoothies who excelled on the parade ground, on the golf course and cocktail parties were replaced by the abrasive two-fisted warriors who were always in some kind of petty peacetime trouble. Guys like Doolittle, Nimitz, Patton and Vandegrift (Nimitz and Vandegrift both received general courts martial as young officers) took over and turned defeat into victory.

In the opening rounds of the Korean War we had our asses handed to us until a warrior leader, Matt Ridgway, took command. He fired the parade ground generals who'd crept back into command spots after WWII and brought in a team of fire-eaters like Throckmorton, Freeman and Michaelious. Then, almost overnight, we started kicking communist ass and winning.

By the time we were stuck in the Vietnam War, Ridgway, who warned we should stay out of Southeast Asia, was retired and the Perfumed Princes were back in charge. Besides placing the wrong guys in charge, the ticket-punching process was ingrained and only a handful of maverick warrior-leaders were left. There were too few Larsens and Throckmortons at the top to prevent the disaster that followed over the next eight bloody years.

From that doomed war's beginning, I watched the hundreds of ticket-punchers creep in, get their punch and ooze out without having a clue as to what was going on down in the paddies. They, while soaring overhead in their helicopters racheting up their air medal count, were the major reason for our battlefield failure in Vietnam. They were badly qualified coaches without a game plan who never had the guts to tell their civilian and military bosses that politics and warfare



"Few officers stay in one job long enough to really learn it. It's hurry through the maze to the next punch. [Current Chairman of the Joint Chiefs of Staff John M. Shalikashvili (above)] was not selected for his war-fighting skill, but rather because he would 'lead the Joint Chiefs to operate more collegially... than we have consistently seen in recent years ...' said a document meant for Clinton's eyes only."

don't mix, and to butt the hell out of the war-fighting decisions.

Westmoreland, a ticket-puncher's ticket-puncher, was busy refighting WWII, and in the process destroyed his hardcore and damned fine regular officer and NCO corps. His three years of criminally inept search and destroy pounded the military's hardcore cadre to a bloody pulp.

All but the brain-dead knew Westy's light-at-the-end-of-the-tunnel vision was a North Vietnamese freight train smashing everything in its path. Yet not one admiral or general resigned in protest. All collected their phony medals, grabbed their stars and went along with the carnage to get along. Imagine the guilt these bastards must now carry. They should all be court martialed, and, if found guilty, lined up against a wall and shot.

After the Vietnam War, study after study concluded that ticket-punching was destroying the U.S. armed forces. The service chiefs — all of whom were master ticket-punchers themselves — simply refused to recognize its existence and chanted in chorus: "Ticket-punching has been eliminated."

Today, the ticket-punching formula is set in concrete. If an O-5 and above doesn't have a master's degree punch, the appropriate command and staff punches running from platoon level to the Pentagon, a chest full of "hav-

ing-been-there medals," and a few powerful generals and defense officials in their pocket, he can kiss the stars goodbye.

Duty, Honor, Country?

Such a system doesn't produce tactically proficient warriors. It stamps out people's courage to stand up and fight for what is right and tell the truth when things go wrong. I, me, mine comes first in a profession built upon a granite foundation of selfless service and duty, honor and country.

Things have changed a whole bunch since WWII when Gen. George Marshall allowed a much junior Dwight D. Eisenhower to become supreme commander in Europe. All Marshall had to say to President Roosevelt was, "I want that job" and the most important military command in history would have been his for the taking; Marshall chose to put country over career and self.

With today's system, Ike would have been trampled to death by a herd of crazed four-star ticket-punchers on the way to their publishing houses to collect big-buck book contracts before hitting the beaches at Normandy — long after D-Day, of course — for a photo op. Just look at the back-stabbing and game-playing that went on with the selection of Colin Powell's replacement as chairman of the Joint Chiefs of Staff. Fifteen four-star generals and admirals competed like dogs in heat for the job. The lowest point was when an Air Force general let leak that contender Gen. George Lee Butler's wife had used a military vehicle for an unauthorized shopping trip while in Europe with the general.

Gen. John M. Shalikashvili got the job. He was not selected for his war-fighting skill, but rather because he would "lead the Joint Chiefs to operate more collegially ... than we have consistently seen in recent years" (so said a document, meant for Clinton's eyes only). Cheerleaders and politically adept smoothies win over war-fighters every time.

Politically correct or not, what

general or admiral has sounded off over the issue of homosexuals serving openly in the military when all whisper off the record that combat effectiveness would be destroyed?

What general or admiral has stood up and fought the politicians insisting the armed forces allow women to serve in combat positions when every study and 220 years of U.S. military experience prove this experiment won't work on the battlefield?

What general or admiral has sounded off concerning allowing married recruits to enter the service even though all know they degrade combat ability and lower morale? When Marine Commandant Carl Mundy said no to married recruits, an order well within his authority, his decision was shot down by former Defense Secretary Les Aspin. Why didn't he tell Aspin he could not work for someone who overturns a militarily correct decision for political reasons and resign?

What serving general or admiral



Photo: UPI/Beitmann

"[Our current] system doesn't produce tactically proficient warriors, stamps out a person's courage to stand up and fight for what is right and tell the truth when things go wrong. I, me, mine comes first in a profession built upon a granite foundation of selfless service and duty, honor and country." Charred bodies lay amid the wreckage of Desert One fiasco in Iranian desert after hostage rescue attempt in 1980.

told Aspin his "bottom up review" is a load of political crap that doesn't make sense and will leave our armed forces hollow and toothless?

What general or admiral has sounded off and said, "Hey, we don't have the fuel, ammo and dough to train, and our combat readiness is dropping like a jumper whose chute didn't open?"

If you said none of the above, you

Continued on page 67



Reasonably priced, the Louis Awerbuck Signature Model starts out as a Remington Model 870 with a number of important added features, such as: "ghost ring" rear sight, front sight blade with vertical tritium bar, SideSaddle shotshell carrier, combat-style magazine follower and nylon sling with quick-detachable swivels.

Secretary of the Treasury, Lloyd Bentsen, at the bidding of his master, Slick Willie, has recently directed the ATF gun gestapo to declare three U.S.-produced smoothbore shotguns as "destructive devices" (i.e., the classification that includes mortars, M79 and M203 40mm grenade launchers, poison gas, bombs, grenades, mines and rockets): the Striker, Street Sweeper and USAS12. It seems they are not "particularly suitable for sporting purposes" — a shibboleth placed into the Gun Control Act of 1968 not by our enemies, but at the insistence of major U.S. firearms manufacturers who feared

Scattergun Technologies' "Politically Correct" Combat Shotgun

Lovable, Yet LETHAL

Text & Photos by Peter G. Kokalis

competition from the importation of cheap, surplus military rifles.

"Political correctness" is an essential ingredient of the left-of-center, knee-jerk liberalism that currently controls our government. While most liberals hate most firearms, guns with a military appearance are especially terrifying to those who fear an armed citizenry. All liberals instinctively know, without recourse to reality, that drug lords decorate their weapons with bayonet lugs, large capacity magazines, pistol grips, flash hiders and black plastic furniture, apparently to intimidate rival drug lords. It is currently politically correct to acknowledge such ridiculous concepts as dogma and respond by attempting to disarm honest gun owners.

Possibly in response to this nonsense, Scattergun Technologies Inc. (Dept. SOF, P.O. Box 24517, Nashville, TN 37202; phone: 615-254-1441, fax: 615-254-1449), together

as a "politically correct" combat shotgun. Scattergun Technologies builds production series practical shotguns and provides a wide range of what they refer to as "Tactical Response" shotguns to armed professionals and to those civilians concerned with providing themselves with a self-defense potential at the highest possible level. Awerbuck's book, *The Defensive Shotgun: Techniques & Tactics*, is generally regarded as the definitive work on this subject.

The so-called "Louis Awerbuck Signature Model" (Item No. 90110) starts out in life as a Remington 870 Police Magnum, a rather plain Jane shotgun with a phosphate ("Parkerized") finish and a totally unnecessary 3-inch Magnum chamber. All Scattergun Technologies' shotguns with 18- and 14-inch barrels are choked cylinder bore, except the Awerbuck Model, which features a modified choke barrel to more effectively utilize the broader range of pellet sizes used by civilians for hunting and self-defense. (The degree of choke, or constriction of the muzzle of a shotgun barrel, is measured by the percentage of pellets delivered to a 30-inch circle at a range of 40 yards. A cylinder bore usually delivers 25% to 35% of the shot into the circle, while a modified choke, will put 45% to 55% of the pellets into the 30-inch circle.) Overall length of this model is 38.25 inches with a weight, empty, of 8.25

"Political correctness" is an essential ingredient of the left-of-center, knee-jerk liberalism that currently controls our government.

with Louis Awerbuck, a *Soldier Of Fortune* and *Fighting Firearms* contributing editor and Yavapai Firearms Academy director, have designed what could be euphemistically referred to



Scattergun Technologies' Louis Awerbuck Signature Model shotgun is an assemblage of all the right components to provide an excellent self-defense smoothbore with legitimate applications for hunting as well.

pounds. It has an 18-inch barrel.

The Model 870 was introduced in 1950 to replace the Model 31 and shares a high percentage of component commonality with the Model 11-48 that appeared in 1949. Side-ejecting and without an external hammer, the Model 870 has a tubular magazine and takedown, interchangeable barrels.

Its method of locked-breech operation has been taken from the John Browning-designed Model 11 semi-automatic shotgun. When in battery, the bolt remains locked to the barrel by means of a locking block within the bolt body, which engages a recess in the barrel extension. Receiver strength is not critical in this system as the recoil forces are mostly absorbed by the bolt assembly and the barrel extension. A steel slide, to which has been attached a stepped lug (also housed within the bolt body), is mated to twin action bars attached to the forearm. When the slide is racked

forward, the front step on this lug moves under the front end of the locking block and pivots it upward to engage its forward projection in the recess on top of the barrel extension. After firing, when the forearm is manually driven rearward, the slide moves back through about a half-inch of free travel, after which the locking block drops downward to unlock the

action. Completion of the rearward cycle by the operator will draw all of the reciprocating parts to the rear and eject the empty shell out the ejection port on the right side of the receiver.

The trigger mechanism's dis-

A SideSaddle shotshell carrier has been attached to the left side of the receiver. Manufactured from injection-molded black polymer, the SideSaddle holds six rounds and provides instant access to spare rounds or alternative types of ammunition, such as slugs.

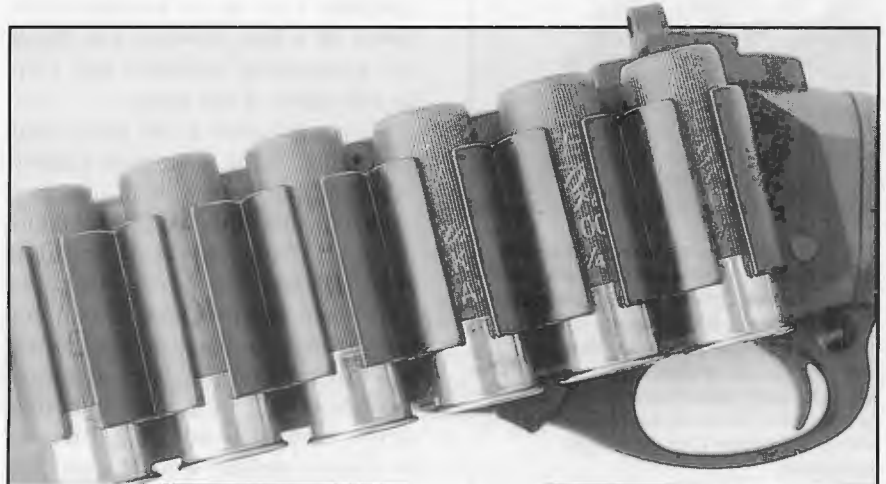

connector, which requires the trigger to be released between each shot, can be actuated both manually by depressing the action-bar lock button and by the fall of the hammer. There is a standard cross-bolt-type safety at the rear of the alloy trigger guard.

The factory wood (dense-grained birch) buttstock and forearm have been retained to lower the anxiety level of those frightened by "black guns." The recoil pad has a beveled top edge to facilitate speed mounts and inhibit snagging on clothing. To further minimize perceived recoil, a sealed aluminum tube filled with mercury and ball bearings has been installed in the buttstock. Length of pull, as measured from the center of the trigger to the end of the recoil pad, is about 14 inches.

One of the most important features of almost all Scattergun Technologies' fighting shotguns, including this one, are the "Trak-Lock" sights. The rear sight consists of a patented chrome-moly steel assembly with a counterbored "ghost ring" aperture, which provides a shadow-like effect with extremely fast sight alignment at close-range buckshot distances — without compromising the requirement for precision sighting with solid projectiles at longer ranges.

Adjustments for both elevation and windage are accomplished through the manipulation of a single screw (an allen wrench of the correct size is provided), which also locks the aperture to the sight base, mating and locking notches on the underside of the aperture body with a corresponding notched surface on the base. A tritium dot on each side of the aperture is

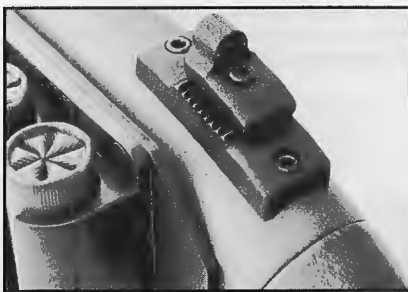

The rear sight consists of a patented chrome-moly steel assembly with a counterbored "ghost ring" aperture that provides a shadow-like effect with extremely fast sight alignment at close-range buckshot distances — without compromising the requirement for precision sighting with solid projectiles at longer distances.

standard on this model.

The exceptionally sturdy, high-profile front sight blade, which is cross-pinned in place, has a self-luminous, tritium vertical bar of Awerbuck's specifications and is installed (as are the rear-sight tritium dots) by IWI (Innovative Weaponry Inc., Dept. SOF, 337 Eubank N.E., Albuquerque, NM 87123; phone: 800-334-3573).

No extension has been added to the standard four-round magazine tube and thus with a round in the chamber, the total capacity is five rounds. This is sufficient for most civilian self-defense applications.

The magazine tube contains a fluorescent green combat-style follower with a projection on the head that instantly indicates by sight, or by touch, if the magazine tube is empty. Molded from non-rusting, high-impact ABS, the follower has a tapered tail to prevent the magazine spring from binding. The magazine spring, designed by W.C. Wolff Co., has been coated by electrostatic deposition with an epoxy-based, paint-like material that is only .050-inch in thickness. Used in the automotive industry as a base coating, this finish will purportedly withstand 600 continuous hours of salt spray.

As a supplement to the four-round magazine tube, a SideSaddle shotshell carrier has been attached to the left side of the receiver. Manufactured from injection-molded black polymer, the SideSaddle holds six rounds and provides instant access to spare rounds or alternative types of ammunition, such as slugs. Rounds should be loaded into this carrier from the bottom, bases down. To remove a shell from the carrier,

FIELDSTRIPPING THE LA870

There are few tricks involved in disassembly of the Model 870 series shotguns. First empty the magazine tube and clear the weapon. Set the cross-bolt to safe. Rack the action rearward slightly to disengage the locking block from the barrel extension. Remove the sling from the front swivel. Grasp the magazine tube's end cap and turn it counterclockwise to separate it from the magazine tube. Pry out the sheet-metal spring cap inside the magazine tube and remove the follower spring. Tilt the gun downward and the follower will drop out the end of the magazine tube.

Pull the barrel away from the receiver. Insert your finger through the underside of the receiver and depress the left shell stop. Move the bolt group and action arms out toward the front. Separate the slide and bolt group from the action arms after they are clear of the receiver. Remove the six small allen-head screws that hold the SideSaddle shotshell carrier to its mounting bracket. Then remove the two larger allen-head screws that hold the bracket to the receiver and replace the trigger mechanism's retaining pins.

Wrenches of the appropriate size are provided. This will permit you to separate the trigger housing assembly from the receiver body. No further disassembly is usually required.

After cleaning and lubrication, reassemble in the reverse order. The most difficult aspect of reassembly is installation of the bolt group and action arms since both the right and left shell stops must be depressed at the same time.

—P.G.K.

simply push down on the top of the shell.

An excellent adjustable sling has also been installed. Fabricated from 1.25-inch milspec black nylon, it's designed for either standard over-the-shoulder carry, hands free over-the-chest or a backpack carry position. It attaches to steel, quick-detachable swivels at the buttstock end and on the magazine tube's front cap.

To facilitate manipulation of the cross-bolt-type safety mechanism, a jumbo-head safety designed by Scattergun Technologies has replaced the standard-issue safety. Manufactured from 4140 chrome-moly steel, it has undercut grooves to inhibit slipping. Trigger pull weight on *SOF*'s test specimen was a slightly creepy 3.75 pounds.

Workhorse loads for the 12-gauge combat shotgun are rifled slugs and No. 00 buckshot. Federal (Federal Cartridge Co., Dept. SOF, 900 Ehlen Drive, Anoka, MN 55303; phone: 612-

323-2300) is my choice for both. Their so-called Hi-Shok\Hollow Point slug (product No. F127-RS), is a one ounce (437 grains, nominal), hollow-base, rifled lead-alloy slug with no more than an incipient dimple at the tip. Nevertheless, this .70-caliber projectile will penetrate up to 14 inches of soft tissue while expanding to 1.1 inches in diameter. The temporary cavity produced is significant and will add to tissue disruption. At 50 yards, this round produced incred-



The exceptionally sturdy, high-profile front sight blade, which is cross-pinned in place, has a self-luminous, tritium vertical bar of Awerbuck's specifications.

ible one-hole three-shot groups, measuring only 1 inch center-to-center, using the modified choke barrel of the Louis Awerbuck Signature Model shotgun sent to SOF for test and evaluation.

I also prefer Federal Premium No. 00 buckshot (product No. P154-00B), which features copper-plated shot granulated filler and a long-range shot cup. Select the nine-pellet load because the 12-pellet, 2.75-inch Magnum load just plain kicks too much. No. 00 pellets have a diameter of .33-inch. Federal Premium tower-dropped pellets are 97.5% pure lead with 2.5% antimony for added hardness. Two polishings guarantee sphericity. Copper-plating further increases resistance to deformation during firing. Shot is arranged in a spiral configuration within the long-range shot cup; granulated buffer is added to fill the gaps. The granulated buffer will eventually leak into the gun's action and chamber, so the mouth of these shells should be sealed with nail polish or clear lacquer.

Another excellent buckshot round is Federal's Tactical Load, a low-recoil police round with nine copper-plated pellets of No. 00 buckshot in granulated filler (product No. H132-00).

At 10 yards, Federal Premium nine-

LOUIS AWERBUCK SIGNATURE MODEL SHOTGUN SPECIFICATIONS

| | |
|--------------------------------|---|
| Caliber: | 12 gauge. |
| Operation: | Slide-action, locked-breech. Locking block engages a recess on top of the barrel extension. Twin action arms. |
| Feed mechanism: | Four-round tubular magazine under the barrel. |
| Weight, empty: | 8.25 pounds. |
| Overall length: | 38.25 inches. |
| Barrel: | Smoothbore, modified choke. |
| Barrel length: | 18 inches. |
| Finish: | Phosphate ("Parkerized"). |
| Furniture: | Dense-grained birch buttstock and forearm. Sealed aluminum tube filled with mercury and ball bearings installed in buttstock. Rubber recoil pad with beveled top edge. |
| Sights: | "Trak-Lock" rear sight with counterbored "ghost ring" aperture and tritium dots; adjustable for both elevation and windage. High-profile front sight blade with self-luminous, vertical tritium bar. |
| Special features: | Six-round SideSaddle shotshell carrier attached to left side of receiver; combat-style magazine follower; magazine spring protected by electrostatic deposition of an epoxy-based, paint-like material. |
| Manufacturer: | Scattergun Technologies Inc., Dept. SOF, P.O. Box 24517, Nashville, TN 37202; phone: 615-254-1441, fax: 615-254-1449. |
| Price: | \$665. |
| T&E summary: | An assemblage of all the right components to provide an excellent self-defense smoothbore with legitimate applications for hunting as well. Reasonably priced. Highly recommended. |

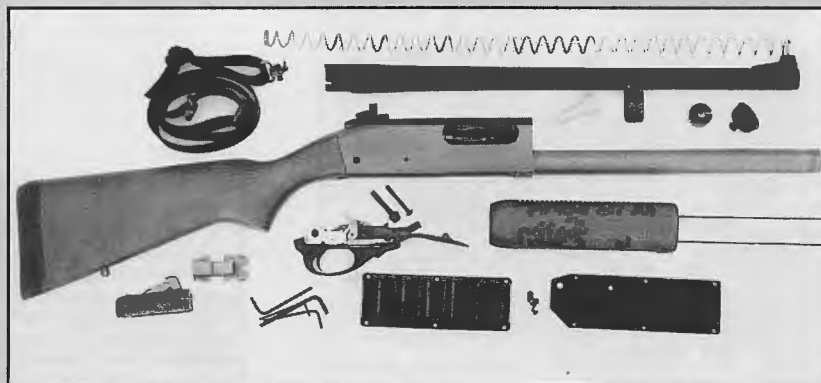

Scattergun Technologies' Louis Awerbuck Signature Model shotgun, fieldstripped.

shot No. 00 buck impacted the target with all the pellets in an irregular 3.5-inch vertical oval. At 15 yards, all nine pellets would still impact into the chest area of the target. At 25 yards — in my opinion the outer limit of acceptable performance with buckshot — seven pellets would still impact into the torso area of a humanoid target most of the time.

Remember, every shotgun barrel, even those of the same make, choke, model and with sequential serial numbers, will throw a pattern different than any other and you must pattern your shotgun at varying distances with the exact loads you intend to employ.

The price of the Louis Awerbuck Signature Model is \$665 and includes a copy of Awerbuck's book and the allen wrenches necessary for adjustment of the rear sight and disassembly of the gun. The receiver is marked under the loading gate with the "L. Awerbuck" signature and "LA 870" under the ejection port, instead of the usual "TR 870" (Tactical Response Model 870).

Scattergun Technologies, with insights from my friend, teacher and co-instructor Louie Awerbuck, has assembled all the right components to deliver an excellent self-defense smoothbore with legitimate applications for hunting as well. ✕

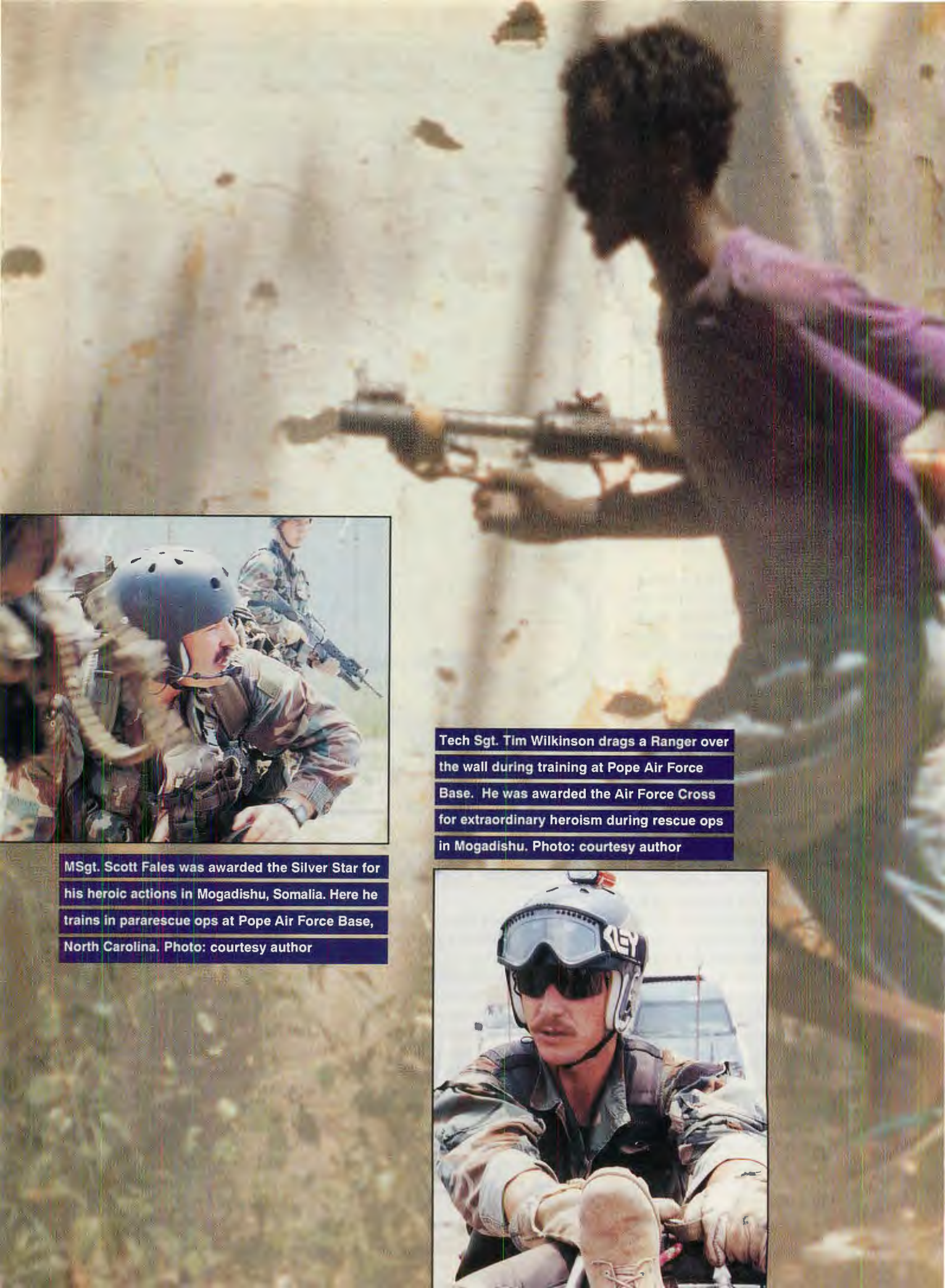

Tech Sgt. Tim Wilkinson drags a Ranger over the wall during training at Pope Air Force Base. He was awarded the Air Force Cross for extraordinary heroism during rescue ops in Mogadishu. Photo: courtesy author

MSgt. Scott Fales was awarded the Silver Star for his heroic actions in Mogadishu, Somalia. Here he trains in pararescue ops at Pope Air Force Base, North Carolina. Photo: courtesy author





Fast-Rope Into Hell

Spectacular Ranger Rescue Op In Somalia

by Dale B. Cooper

“In a firefight, life is a series of interrelated instances. Your continued existence is determined by inches and nanoseconds. Scenes become snapshots frozen in time, everything in slow motion. The air is void of sound, yet you are immersed in ear-shattering thunder. All your senses are crisp, adrenaline pumping, your mind screaming.

“All around you are heroes, just men, doing heroic things. Not for patriotism, not for the God-forsaken country you’re saving, but for the men around you, your comrades, your teammates, your friends, your brothers.

“Never forget, this is when Death watches and waits for his chance to steal your life. Because it’s during those instances you are most alive.”

Air Force Master Sergeant Scott Fales wrote those words while recovering from wounds he sustained during a 15-hour firefight last October in Somalia. The firefight left 18 U.S. servicemen dead, 84 wounded and one captured: Chief Warrant Officer Michael Durant, the lone survivor of six men aboard a Blackhawk helicopter shot down by a Rocket-Propelled Grenade (RPG).

The downing of Super 6-4 (the call sign of Durant’s helicopter) made headlines around the world. Durant’s battered, bruised and bewildered face staring out from the cover of news magazines was forever etched in the American psyche like the Challenger explosion.

Somali “shoots and scoots” after firing
RPG-7 at U.S. troops in downtown
Mogadishu. Though originally designed as
antiarmor weapons, RPGs shot down
two American Blackhawk helicopters
during debacle last October. Photo: SOLO



But another helicopter was shot down 3 October in Mogadishu, and men died. The men who went to their rescue didn't make headlines, they just did their jobs — as a result, six of the eight-man crew survived. Even more remarkable is the fact that none of the Combat Search And Rescue (CSAR) team members who went to the chopper's aid were killed.

Fales and Technical Sergeant Tim Wilkinson, both pararescuemen, or "PJs" as they are commonly called, and Staff Sergeant Jeff Bray, a combat controller, are members of the 24th Special Tactics Squadron based at Pope Air Force Base in Fayetteville, North Carolina. The 24th is the most highly decorated squadron in the Air Force and after reading this story you'll see why.

Daylight Ranger Raid

The mission of Task Force Ranger was to round up those Somalis responsible for the May '93 massacre of 23 Pakistani peacekeepers, including fugitive warlord Mohamed Farrah Aidid, who was believed to have masterminded the killings. Intelligence sources indicated that 24 of Aidid's

loyal followers were meeting at the Olympic Hotel on 3 October.

At 1540 hours local, 20 Delta Force commandos supported by about 80 Army Rangers and Bray as combat controller swooped down on the hotel in helicopters and captured two key Aidid lieutenants and 22 other Somalis during a 15-minute raid.

Forty minutes later, while members of the task force were preparing to transport the detainees back to the airfield for interrogation, the first of two Blackhawk helicopters to be shot down was hit by an RPG. Super 6-1, the call sign of the damaged helicopter, spun out of control and crashed nose-first into a narrow alley off Freedom Road about five blocks northeast of Task Force Ranger's location.

Although the pilot and co-pilot were killed on impact, Super 6-1 was lucky. It didn't explode and burn after slamming down and shearing off its rotor blades while rolling onto its left side.

Command and Control advised the CSAR team that there were eight people on board the downed Blackhawk: two pilots, two gunners and four passengers (members of Task Force Ranger).

Somali gunman with folding-stock AK looks on while "civilian" spotters point out targets. Somali small-arms fire was like a blizzard of lead, according to CSAR team members sent to rescue downed chopper crewmen. Photo: SOLO

What they didn't know, however, was that two of the passengers, a couple of wounded Delta snipers, had been picked up by an MH-6 Little Bird. The MH-6 pilot laid down covering fire with his M16A2, pointing it out of the cockpit of his unarmed observation chopper, while the co-pilot dragged the commandos to his bird and put them on the skids.

"We knew the assault force [at the Olympic Hotel] was heavily engaged and couldn't reach the downed chopper," Fales told me — at the hotel a truck driver had been decapitated by an RPG, and AKM rounds continually splattered against the armored glass windshield of the task force commander's Humvee. Before the task force could withdraw, it suffered 6 KIA

and 20 WIA and would lose 7 of its 12 trucks to machine gun and RPG fire.

As the "shot clock" for the rescue team began to tick down, Fales held up one finger, signalling team members they had 60 seconds to check one last time to make sure their rappelling gloves were on and their weapons were locked and loaded. Everyone checked each other and passed the rappelling ropes to the center man sitting in each doorway.

PJs Go In Hot

As the rope was kicked out his side of the aircraft, Wilkinson saw it catch on a telephone wire. The pilots had to lift the tail of the aircraft and pull it forward, so the tail wheel wouldn't snag the line and pull them down — all the while taking heavy ground fire.

As the time approached to leave the aircraft, Fales and his fellow PJ took one last look at each other. Both men said goodbye with a simple nod. Neither had time to think about their wives and children. It was all business. Men's lives were at stake.

Fales and Wilkinson were the last to leave their Blackhawk and fast-rope to the street below. In addition to wearing hard-plate body armor and carrying a 40-pound medical rucksack with life-giving fluids and battle dressings, the

PJs were weighted down with M16A2 M4 carbines, M9 Beretta pistols, hand grenades, water and an assortment of other gear including hand-held Motorola radios.

The only lightweight piece of gear worn was a Pro-Tech plastic helmet. The hockey-style helmets will not deflect a piece of shrapnel, but PJs like them because lights can be strapped to them on strips of Velcro, freeing up their hands.

Fales carried seven magazines of 5.56x45mm ammunition, Wilkinson about five. Although they are supposed to treat the wounded, sometimes they have to kill the bad guys before they can administer first aid to the good guys.

Fales was the last to leave the left side of the aircraft; Wilkinson was the last man out the right side in what he calls a "controlled fall." Tracers were flying past the doors continuously as the team inserted. As Wilkinson and Fales "fell" the 40 feet to the ground, their bird, Super 6-8, took a direct hit. An RPG struck the main rotor system and exploded in a thunderclap and shower of razor-sharp shrapnel.

The normal tendency of a helicopter pilot who feels his aircraft take a hit and shudder, is to transition to forward flight and depart the area. However, this pilot held his hover until the door gunners yelled "clear" and hit the quick release handles, letting the ropes fall away.

By the time Super 6-8 limped back to the airport, it had lost all its oil and hydraulic fluids. The crew got out of their wounded Blackhawk, fired up a spare aircraft and rejoined the fight.

Fight To The Crash Site

Once on the ground, five of the 16-man CSAR team went up the left side of Freedom Road with Fales toward the crash site; 10 others, including Wilkinson, moved up the other side of the street, but nobody knew exactly where the wreck was located. From where he was sitting between the two gunners, Wilkinson couldn't orient himself to the crash site from the air before he rappelled to the ground.

It wasn't until Fales and the men on his side of the street reached a burned-out hulk of a car at an inter-

section that he could see a "big, huge ball of green crap" halfway down a narrow alley. Moments later, Fales realized he was looking at the downed helicopter. Tail boom crumpled. Rotor blades gone. Wilkinson also saw



Somali militiaman fires his H&K G3 at American relief force. Somalis made use of narrow, walled streets to inflict heavy casualties on U.S. forces who could not return fire indiscriminately due to civilian presence. Photo: SOLO

the wreckage and moved toward it, but immediately had to duck into a courtyard to escape a torrent of bullets coming down the street.

"You could hear them, *snap, snap, snap*, and feel the shockwaves past your face," Fales said. In between the snaps were the *whooooosh booms* of RPGs impacting.

An RPG with Wilkinson's name on it came roaring up the street, but took a sudden nose-dive and exploded short of where the pararescueman was hunkered down. With the roar of battle around him, Wilkinson never knew someone was trying to nail him. It wasn't until after the firefight that someone told him of the close call. But death was all around the CSAR team that day.

The alley in which the Blackhawk crashed was only 15-foot wide and lined with 10-foot-high stone walls. Up until Bray arrived later in the day with 12 Rangers from the assault package that attacked the Olympic Hotel, Somalis were "sneakin' and creepin'" behind the walls, hurling grenades into the alley. Once reinforcements arrived, the Somalis were shoved back a

Somalis suffered oppressive casualties: They claimed losing 312 KIA and 814 WIA during 15-hour firefight with American specops troops. Photo: SOLO





few yards out of hand-
grenade range.

That didn't stop them. They crawled into

two-story buildings and poked their gun barrels under the eaves where the tin roof met the walls. They didn't aim — just hosed down the street and let the bullets bounce off the stone walls.

Judging by the volume of automatic weapons fire, Fales perceived the Somalis were about to overrun the crash site when his team arrived. Freedom Road had become a wind tunnel for bullets. Thousands of AK-47 rounds were ricocheting off store fronts and stone walls.

Saving Lives Under Fire

Time plays tricks on soldiers in combat. According to Wilkinson, time was a crisp combination of “stop-frame photography and Mach-3 blur.”

Fales only looked at his watch twice during the 15-hour firefight. The first time was when he was told he was one minute from insertion into a hot LZ. The last time happened at midnight as the ferocity of the firefight faded and he realized for the first time that there was a good chance he and

U.S. Army troops train in Somalia with the armor that was sorely needed on 3 October to rescue the Rangers at the Olympic Hotel and the crewmen of two downed helicopters.

Photo: SOLO



his comrades might live to see another sunrise.

“You're hearing and assimilating information so fast, your mind is screaming,” Fales said, “but you are reacting to it.”

When Fales was finally able to reach the helicopter, he found only one survivor able to move who informed him that two of the eight men aboard had been picked up by another helicopter. The passenger had some deep facial cuts, but was still able to function. Fales then reached through the shattered wind screen to remove one of the dead pilots and was hit by an AK-47 bullet in the calf.

“At first, it felt like someone tugging on my pants leg,” Fales said, “but then it felt like someone stuck me in the leg with a red-hot poker.”

Rolling behind a pile of rocks, Fales took the scissors from his rucksack of medical supplies and cut open his pants leg. He thought the pain would be excruciating when he stuffed a battle dressing into the hole in his leg, but it wasn't that bad. With the help of a Ranger, he hobbled to the rear of the aircraft where the crumpled tail boom offered some, but not much, protection. From here on, the wounded would treat the wounded.

“We were right in the middle of Bad Guy Country,” Fales told me, “and the only thing we could do was seal off both ends of the alley in order to keep them out until we could shove them back away from the crash site.”

Fales believes the Somalis could have overrun his position had they massed their forces instead of feeding them piecemeal into the firefight. But according to Wilkinson, that didn't happen because the So-

A request for American armor was denied by Secretary of Defense Les Aspin one month before the deadly raid in Mogadishu. U.S. Humvees proved too lightly armored to allow the quick reaction force to punch through the well-armed Somali defenders.
Photo: SOLO



malis commanders didn't know how many men they were facing. Thirteen Rangers fought like a reinforced company. They engaged only targets they could see, and their return fire was deadly. The Somalis claim they lost 312 KIA and 814 WIA in the 15-hour firefight around the hotel and crash site.

One of the CSAR's Rangers, Sergeant Pat Roberts, used helicopter gunships to keep the Somalis from overrunning his position. The Blackhawks laid down tremendous volumes of mini-gun and rocket fire. The twin mini-guns can spew out 2,000 rounds per minute, a solid stream of lead.

When the gunships made a low-level pass, the falling brass and spent links sounded like a hailstorm. The volume of hostile fire would drop dramatically as the gunships made their runs, but as soon as they flew back to the airfield to rearm and refuel, the volume of fire would build to another crescendo.

Blizzard Of Lead

As soon as his buddy went down with a bullet in the leg, Wilkinson rushed forward to help one of the badly injured gunners propped up against a stone wall in the alley. Giving him a quick once-over, Wilkinson braved heavy automatic weapons fire and a torrent of grenades as he climbed into the downed Blackhawk and pulled one of the deceased pilots from the wreckage. The body of the other pi-

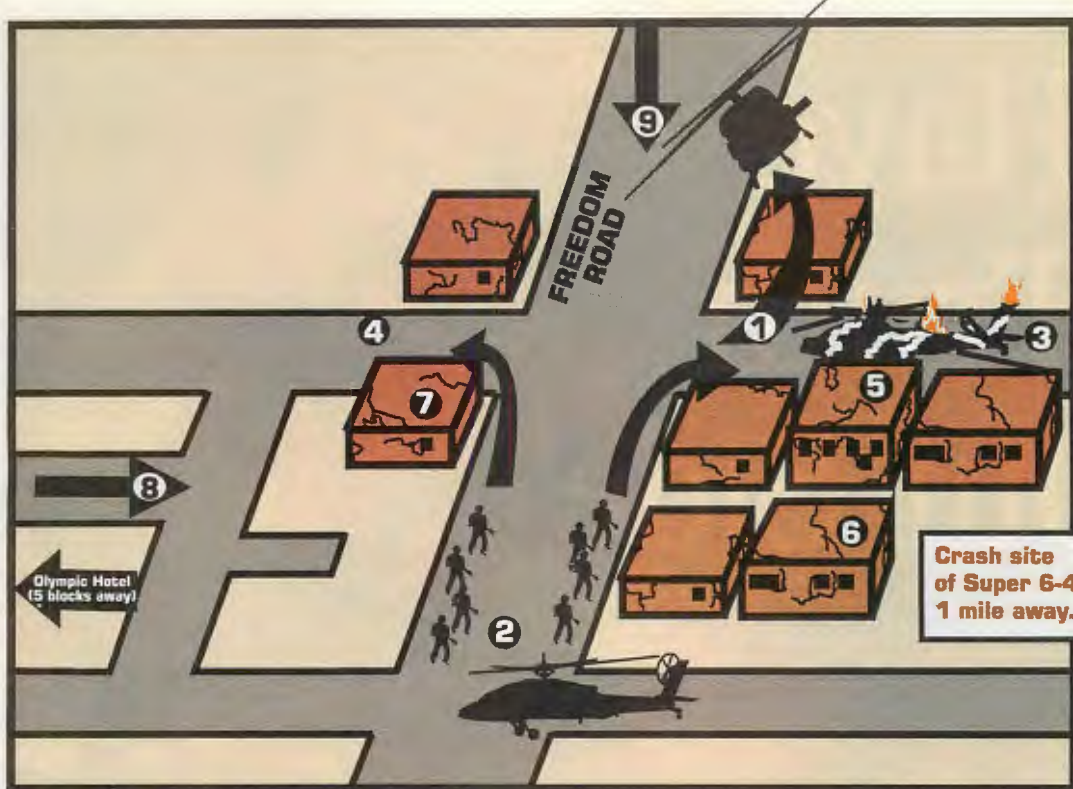

- 1 Super 6-1 crashes in a small alley off Freedom Road: two killed, six wounded. Two are extracted in a daring rescue by MH-6 Little Bird.
- 2 CSAR team deploys from Super 6-8, which is hit by an RPG and limps back to base.
- 3 4 CSAR team tries to secure crash site and extract wounded. Twelve of the 16-man team are hit.
- 5 6 Fales retreats into house with wounded; when RPG fire becomes too heavy, his team blows out rear wall and eventually retreats into back building.
- 7 Wilkinson runs the gauntlet of enemy fire across Freedom Road to treat wounded Rangers.
- 8 Detachment of Rangers from the raid on Olympic Hotel links up with CSAR team. Armed convoys are repeatedly ambushed and turned back. Bray calls in gunships throughout the night on Somali positions.
- 9 Quick reaction force with four Pakistani tanks and 28 Malaysian APCs links up with CSAR team next morning. Map: Kristine Anderson

lot, CWO Clifton P. Wolcott, was solidly pinned in.

While surveying the damage inside the chopper's cabin, Wilkinson noticed a piece of desert BDU clothing sticking out of the wreckage. He had found the port gunner pinned in a sitting position against the left side of the aircraft.

While Bob Mabry, an Army medic with the Rangers, tried to crawl under the aircraft to free the trapped gunner, Wilkinson began prying pieces of wreckage away in the cabin. Just as they freed the man, a shower of bullets ripped through the aircraft.

"The alley just erupted into a blizzard of lead, and all three of us were hit," Wilkinson said. The badly injured gunner had the tips of two fingers on one hand sawed off by machine gun bullets. Wilkinson got hit in the

hands, face and arm by shrapnel.

Mabry had the presence of mind to pry up kevlar floorboards in the cabin and prop them up as "bulletproof" shields while he and Wilkinson slid the injured crew chief outside the aircraft. The makeshift shields were knocked down a few times, but they kept the bullets from doing any more serious damage.

In addition to treating wounded comrades, PJs are also trained to "zeroize" all of the crypto gear in the helicopter. Push the right buttons, and the black boxes erase their memory banks. Fales and Wilkinson also knew how to "save and destroy" weapons like electrically operated mini-guns. Once the body of the pinned pilot was removed, an EOD (Explosive Ordnance Demolitions) expert, who was part of the CSAR team, destroyed the air-

craft with C-4 explosives and thermite grenades.

With casualties mounting, it became imperative to improve the team's defensive position; but every time someone got up, they went down. Three Rangers were hit across the street from where Wilkinson was helping treat the wounded at the casualty reception center set up behind the tail boom of the downed chopper.

An hour after arriving at the crash site, all souls aboard the helicopter had been accounted for. At this point, Fales was told that the assault element of Task Force Ranger trying to break through to them had been turned back by heavy fire.

With the exception of Bray and the 12 Rangers who had linked up with them after fighting five blocks from the hotel, there would be no relief for Fales in the immediate future. There was no feeling of de-

spair: Fales had decided to fight to the last man and the last bullet if necessary.

As darkness fell on the battlefield, spirits were lifted when a Blackhawk came in low and hovered as crew chiefs kicked out cases of water, ammo and medical supplies.

Up until nightfall, the Somalis were dictating the pace of battle, but when darkness fell over Mogadishu, they could no longer see their targets. The Rangers had a few pairs of Night Vision Goggles (NVGs) and used them to spot and neutralize Somali staging points. Fales told me he will never leave home again without his NVGs, even if the mission is supposed to be a daylight job.

As the night wore on, the Somalis

Continued on page 65

"We Have The Truth On Our Side"



Jailhouse Interviews With Branch Davidians

Text & Photos by James L. Pate

The stone-faced female jailer ordered Clive Doyle to put his hands behind his back. Bowing his head, Doyle wore a defeated look as handcuffs snapped into place one last time and he was led through a massive steel door at the Bexar County Jail in San Antonio.

Doyle's mother, Edna, watched in disbelief, her mouth agape. This was Doyle's day of victory: A few hours earlier, the Australian native was freed in the same courtroom he had sworn his oath of U.S. citizenship in 1985. A half-hour later, when he entered the Polo Lounge at the Fairmount

Hotel looking for his attorney, the lawyers, journalists and others celebrating gave the embarrassed Doyle a standing ovation.

Quite a contrast from 10 months earlier, when a badly burned Doyle lurched from Mount Carmel's raging inferno into the custody of heavily armed FBI agents. Doyle was arrested and jailed, denied any bond. After enduring a year of siege, captivity and trial, this final indignity was insult added to injury.

"Wait a minute!" I protested to the jailer. "You shouldn't

Mt. Carmel burns: Government agents testified fire broke out first in portion of building at lower right of photo. However, photo shows gym area, flattened by armored vehicles (top right of photo), was already in conflagration. Renos Avraam escaped to roof (center), jumped to ground and was captured by FBI. Eighty-one others were not so fortunate. Photo: FBI

put handcuffs on him. He's a free man. He was acquitted of all charges." I had brought Doyle and his mother to the jail to collect his paper bag of belongings.

"Sorry," the matron said flatly. "Regulations."

Edna Doyle, her white hair in a neat bun and steel-framed spectacles perched on the end of her nose, watched with furrowed brow as her 53-year-old son disappeared behind the echoing steel door. "It's not right," she whispered to me, cupping her hand around her mouth, wary of several nearby deputies. "The burns on his hands and arms still haven't healed all the way. Those handcuffs hurt him. These people are just mean."

So it seemed. But Doyle appeared above all that. In his first remarks to the public upon being set free, and in a two-hour interview with me for *Soldier Of Fortune* the following day, he seemed remarkably free of bitterness. Despite the death of his own daughter, Shari, in the fire, Doyle expressed sorrow that four ATF agents had died.

Renos Avraam and Livingston Fagan, convicted of aiding and abetting voluntary manslaughter in the four ATF agent deaths, also answered questions for *SOF*. Like Doyle, they remain undaunted, continuing to insist their version — that ATF agents opened fire first — is the truth. The unshaken beliefs of the Branch Davidians still sound odd to mainstream religionists, but the perceptive listener is impressed by the depth and strength of their faith.

It is a faith sorely tested.

"We've lost everything," a tearful Doyle said as he emerged from the courthouse to be surrounded by reporters and photographers. "We're starting from scratch and I don't know what to do ... The Branch Davidians are not anti-government. I'm sorry four agents are dead, but those in charge of that agency are responsible for that."

It Didn't Have To Happen

When the raid occurred, Doyle told me, "I didn't even know there was such a thing as the ATF. I had heard of Elliott Ness and the Untouchables ... I didn't know they still existed ... I don't have any animosity toward them, then or now, especially the line agents, the street guys. I figure they were just doing what they were told."

Doyle also lost two "very close" friends. One, Perry Jones, known by Doyle since 1966, was mortally wounded in the initial volley of gunfire ATF agents sprayed blindly through Mount Carmel's front door. (Despite numerous eyewitnesses who say Jones died within the hour of an agonizing abdominal gunshot wound, the government-appointed medical examiner insisted that Jones committed

suicide with a gunshot to the mouth. Witnesses said Jones had no head wounds.)

"I feel very bad about it," Doyle said of the deaths in the ATF raid, and the subsequent deaths of 81 other Branch Davidians in a fire that erupted during the FBI's armored and chemical warfare assault 51 days later. "It was unnecessary. I hope it wasn't in vain ... It didn't have to happen at all."

While accounts by ATF agents about how the gunfight started have varied and evolved as the case came to trial, the Branch Davidian story has not changed in any detail.

Avoiding bloodshed would have been "simple," Fagan said in his jailhouse interview. "The ATF could have knocked on the door."

"David came to the door and tried telling them that we had women and children inside," Avraam recalled. "I think he knew how the ATF operates. I believe they shot one of the dogs first, or someone threw a flash-bang grenade into the dog pen."

"The first shots were fired outside," Doyle agreed. "The first thing I heard was David talking at the front door ... Then the eruption of gunfire."

All three remain convinced that David Koresh would have allowed the ATF agents in if they approached peacefully with a search warrant. (During the trial, it came to light that no agent charging the door had a copy of the warrant, or had even seen it. In practice runs at Fort Hood, where they underwent training by Army Special Forces,

the ATF never rehearsed a peaceful entry, although they never obtained a no-knock warrant.)

"I really think he would have [allowed the ATF a peaceful entry]," Doyle said. "David had never been threatening. He always welcomed people in. He had given the invitation to sheriff's deputies to call or come out if they had any questions about anything. A Texas Ranger had come out there. He was welcomed. Deputies came out on a social basis ... to fish, trade guns or car parts, talk about cars or guns. They would drive by and wave, very friendly."

"He had let other people in,



"We've lost everything," a tearful Doyle said as he emerged from the courthouse. "We're starting from scratch and I don't know what to do ... The Branch Davidians are not anti-government. I'm sorry four agents are dead, but those in charge of that agency are responsible for that."

including policemen," Avraam confirmed. "Why wouldn't he let the ATF in? They never gave him the opportunity. So we will never know."

Doyle said the Davidians were suspicious when the ATF undercover agents moved into the house across the road. Mark Spoon, who worked for the EE Ranch, had told the Davidians that the ranch owner planned to remodel the then-empty undercover house.

"So David offered to send guys over to help him with the work," Doyle said. "They worked on it for weeks ... There were four or five guys, sometimes six." Spoon planned to move into the newly refurbished house, and the crew would then remodel the Spoon residence. Then Doyle heard that Perry's housekeeper, who was black, was moving in. "The next thing we knew, these four guys move in, none of whom are black," he said. "This is really suspicious, strange."

The four undercover ATF agents told the Davidians they were students at the nearby Texas State Technical College. Noting their new clothes and their new, expensive vehicles, the Davidians became more suspicious. Wayne Martin, a Harvard Law School graduate who practiced in Waco and lived at Mount Carmel, checked the phony names with TSTC: The registrar's office said no such persons were students.

"One night, some of the guys said we should go over, maybe three or four guys, and welcome them to the neighborhood," Doyle recalled. "They took a six-pack and went over and there were cars in the drive, but the house was dark. So they knocked on the door."

Lowering his voice to a hoarse, conspiratorial whisper, Doyle said the agents responded, "'Who is it!' So they said they were from across the street and wanted to welcome them to the neighborhood and brought over a six-pack. Could they come in? 'No! You can't!' " said Doyle, doing the hoarse whisper again, breaking into laughter. " 'I got my girl in here.' And all of a sudden this hand reaches out, grabs the beer and slams the door."

Bearing No Grudges

In a testament to his humanity and religious faith, Doyle not only bears no grudge toward the agents who attacked his home, he said he is concerned about their spiritual salvation, especially that of Robert Rodriguez, the undercover agent who visited Mount Carmel on a dozen occasions prior to the raid.

"We'd heard them shooting at their house before they showed up," Doyle said. "David had suggested that they come over to target shoot. He already knew that these guys, whoever they were, definitely weren't who they said they were. They'd brought their own guns ... and David asked them if they minded if he looked at their rifles. But he didn't just *look* at them. He took them apart, pulled the

bolt out, and poked around in the trigger mechanism. He told us later you could tell these weren't everyday, off-the-shelf guns, that they'd been worked on, 'tuned up,' he called it.

Loving Their Enemies

"In spite of all that, they were considered just like everybody else out there — souls to be saved," Doyle said. "Then Mr. Rodriguez started coming over more and more. David really wanted to get across to them [his theological message]. Apparently Mr. Rodriguez was very torn by all this ... His other three buddies were pretty upset and figured that he might need therapy, that he was becoming too sympathetic with us."

Rodriguez confirmed during trial cross-examination that statements he made in an interview with Lee Hancock of *The Dallas Morning News* were accurate concerning "my feelings" about the Branch Davidians and his exposure to their unusually apocalyptic theology.

"David Koresh spoke much about the Bible and a lot about himself," testified Rodriguez. "He knew what he was talking about." Rodriguez acknowledged the accuracy of a statement to Hancock, that "after a while, it gets to you, it affects you. You sit there and listen and it starts to make sense."

Describing the routine at the compound, Rodriguez began to weep, obviously torn between his anguish over the deaths of fellow-agents and his feelings about the unjustified deaths of scores of decent people at Mount Carmel. He said he saw lots of children and dogs playing, bicyclists and joggers — probably including Koresh — "and one disabled child in a wheelchair, dropped off and picked up by a school bus each day." In the month he spent conducting surveillance, though, Rodriguez said he never saw *any* illegal activity, or any weapons, except those he took there.

When Rodriguez made a statement to the Texas Rangers the morning after the raid, Assistant U.S. Attorney Bill Johnston, who was directly involved in the raid planning, inexplicably showed up to monitor the interview. Rodriguez told the Rangers that his ATF supervisors were "constantly pressuring us to infiltrate the compound" more rapidly. "We kept telling them the time was not right." Once Rodriguez realized the ATF had lost the element of surprise, he tried to call off the raid. The supervisors, Phil Chojnacki and Chuck Sarabyn, ignored him and, in the wake of its disastrous failure, lied and altered documents in an attempt to blame Rodriguez for the outcome.

"It should never have even gotten to that morning," Doyle said. "They should have just drove past. Nobody would have known. They wouldn't have lost face. But [ATF case agent Davy] Aguilera and all those guys had



Avoiding bloodshed would have been "simple," Fagan said: "The ATF could have knocked on the door ... If somebody comes into your house, where your wife and your children are, and threatens you, what are you going to do? Roll over and die?"

delusions of grandeur ... Those four agents and their families, all of us at Mount Carmel — everyone who's been touched by this — were victims of their vanity."

Wealth By Vanity

In contrast, Fagan and Avraam are striking in their selflessness. Their discussions about what happened were framed less as complaints than as a spiritual challenge. Despite widespread reports to the contrary, life at Mount Carmel was not communal. Individuals retained private property, down to putting names on washcloths, and private capital. Paul Fatta was a millionaire when he moved there, and remains one. But asceticism was a big part of Branch Davidian life. Government authorities used aspects of these practices — their lack of flush toilets, for instance — to ridicule their lifestyles.

Doyle, Avraam and Fagan, and probably the rest of the flock, could not care less.

"The whole concept of Christianity is that people are not happy with the way they are," Doyle explained, that "they want to improve themselves.

Christ's message was that way, and also various other prophets in the Bible. In that same concept is the idea that the cares of this life, the luxuries of this life, are illusion, the things of this world that take your mind off of, separate you from, being able to be one with God."

If the Davidians were less interested in physical treasures, the "law enforcement" mob that descended on Mount Carmel life weren't above carting home a little booty. Examples:

- Thousands of dollars' worth of specialty tools and three \$600 air compressors disappeared from the Mag Bag garage after the raid, when it was smashed and ransacked by ATF agents driving Bradley armored fighting vehicles.

The non-Davidian owner, standing with keys in-hand, was arrested when he tried to prevent ATF agents from wantonly destroying his property.

- An unopened church safe containing more than \$50,000 in cash, personal valuables

of several members, plus gold coins and spools of platinum owned by Koresh was found in the ashes by Texas Rangers, trial testimony confirmed. Signed over to the FBI by Rangers, the safe failed to turn up on the feds' evidence list.

- A strongbox Koresh kept in his Chevrolet Camaro disappeared, along with several souvenir pieces off the classic automobile, including the steering wheel.



"He had let other people in, including policemen," Avraam confirmed. "Why wouldn't he let the ATF in? They never gave him the opportunity. So we will never know."

While accounts by ATF agents about how the gunfight started have varied and evolved as the case came to trial, the Branch Davidian story has not changed in any detail.

for a duplicate. Yet he tries to remain stoic.

"It's hard," he admitted to Dallas-based author Dick J. Reavis. "Now that the trial is over and I see what they've done to guys who are in jail, my numbness is turning to anger."

Doyle's former co-defendants — Fagan, Avraam, Brad Branch, Graeme Craddock, Jaime Castillo, Kevin Whitecliff, Paul Fatta and Ruth Riddle — continue to be singled out for special treatment. Instead of being returned to the McLennan County Jail in Waco, where they received regular visits from friends and supporters, they were moved to the County Jail in Gatesville, 45 miles west.

Those headed to prison marvel at their situation with

little hint of regret. "I believe that we have the truth on our side," Avraam said. "I stand for my freedom to believe whatever I want to believe. I'm sorry that so many people died. I believe it could have easily been avoided. The ATF

lost some of their people. We lost all the Davidians. Imagine how the families feel. Myself and the other defendants are getting blamed for someone else's bad judgment. But I will stand firm ... I'm going to hold on to what I believe until the end."

Continued on page 71

- The government even hopes to seize the ground itself, a 77-acre tract of prime ranch property, attached by liens filed by the state to cover costs of the chain link fence, 24-hour security guards and "clean-up."

There Shall The Vulture Be

Meanwhile, the surviving Branch Davidians, struggling to put their lives back together, hold little hope of rescuing their property from financial predators. Neighboring ranchers are already planting and harvesting the property, as if it was their own.

Doyle, an experienced printer, tried to get a job through the Waco employment office, but was turned down because he can't prove citizenship: His certificate burned in the Mount Carmel holocaust. The Immigration and Naturalization Service said it will take six months

RUSSIA'S secret WEAPONS

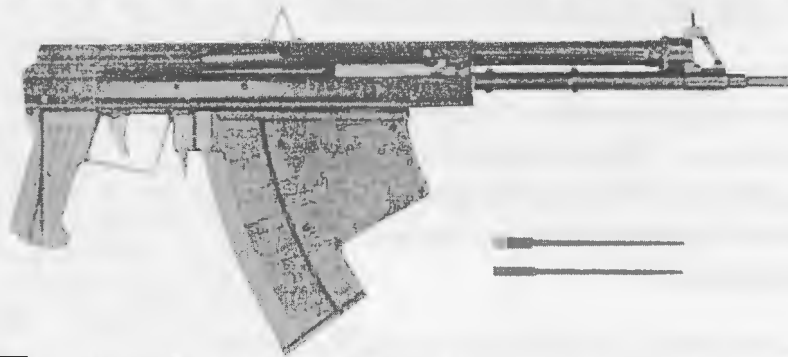

by *SOF* Staff

Unique, powder-propelled projectiles from this 5.66mm Underwater Assault Rifle have 30 meters lethal range at 5 meters depth, 100 meters lethal range above water. Weapon can be fired underwater, into water, or from water to land. Loaded weapon weighs 7.5 pounds, has unusual "Grease Gun" sliding wire stock.

The Russians have never enjoyed a reputation in the West for technological innovation in weaponry — mainly because the old Soviet Union usually provided their clients with obsolescent gear, while keeping their latest developments secret until they themselves could field it. But with the concurrent demise of the USSR and Russia's need to generate hard currency, things have changed. The Russians are now offering their latest and best weapons on the international arms market.

Most of these high-technology weapons are also high-visibility, high-cost items such as MiG-29 and SU-27 combat aircraft and T-80 tanks, but the Russians haven't ignored the grunt market. Recently, new and radical specialized small arms have emerged from Russian weapons design bureaus. Most were a surprise to Western military analysts, who had come to believe the potential for innovation in small-arms design, even in the West, was limited. These weapons are intended for special operations forces, and open sources indicate some already equip Russian *Spetsnaz*, MVD (interior ministry) specops detachments and former KGB forces, though some of the weapons may be only working prototypes.

Little is known of any of these firearms other than the information con-

tained in the manufacturers' brochures, although some have been available for limited range-firing at arms shows. What is clear and significant is that for the first time the Russians have developed true small-arms "systems," incorporating the ammunition, firing platform and sighting into integrated packages. The information in this article is based on data from Russian sales brochures and from articles in the Russian and Western press.

"Vul" Silent Pistol

The PSS "Vul" claims to be "the spy's most ideal weapon" and differs from conventional Western suppressed/silenced firearms in that it uses suppressed ammunition to reduce noise, rather than an external suppressor. This approach enabled engineers

to produce a suppressed weapon comparable in size to a Makarov pistol — a major advantage over small arms with bulky external suppressors. This design also precludes loss of suppressor effectiveness with continued use.

The PSS is clearly useful as an assassination weapon, as it gives special operations and security personnel a small, easily concealed, suppressed pistol without the bulk normally associated with conventionally silenced firearms. The "Vul" was designed by Yuri Krylov and Viktor Levchenko.

The first example of the Russian technology employed in this silent round was uncovered in 1990 by *SOF* writer Ed Bishop in El Salvador (see "Mystery Bullet," May '90 and "Silent Killers," July '90), when Bishop brought back ammo samples for examination by *SOF* Tech Editor Peter Kokalis. This captive-piston round, held and chambered in a two-round clip, was fired in a two-barrel, over-under, double-action pistol, not unlike a two-shot version of an upscale Mossberg "Brownie."

The principle employed in the SP-

2 round fired in the Vul and the longer "7.62x62.8mm" round used in its two-shot predecessor are similar to that of the "Bigot" project of World War II, the Frankford Arsenal XM76 project of the '50s, the AAI Corp. 12-gauge "teleartridge," and the Aberdeen Proving Ground QSPR revolver of Vietnam — using a captive piston or internal spigot to propel the projectile and in turn seal/contain the powder gas from which it was powered.

The SP-2 cartridge was designed by Viktor Petrov and has a heavier case wall than conventional ammunition. This is necessary because the gases are completely contained within the cartridge casing after the bullet is fired. The reliability and effectiveness of this semiautomatic pistol and its associated ammunition cannot be determined, but it appears to be either blowback or delayed-blowback operated, indicating the cartridge is of relatively low power.

The SP-2 cartridge is also used in the "Special Scout Knife," which, given the manner in which it is fired, probably must use a cartridge having low recoil. The projectile of the SP-2 round is a hollow-point cylinder, with a cuprous driving band at the forward end. The construction of the round appears more that of an assembly-line item than the earlier round uncovered by *SOF*; it is significant that it is designed to function in a semiautomatic pistol.

According to the Russian military newspaper *Krasnaya Zvezda* (*Red Star*), the SP-2 cartridge approximates the 9x18mm Makarov in effectiveness. The actual barrel length of the Vul is very short, given the overall length of the cartridge and the distance from the slide face to the muzzle. Most of the space would be occupied by the suppressed cartridge, leaving little distance for rifling to stabilize the bullet. The Vul appears unrelated to either the Makarov or Stechkin pistols and is probably double action.

P-9 "Gurza"

If the PSS is at the low end of the pistol power, the P-9 "Gurza" represents the opposite end of the spectrum. With its 9x26mm cartridge, the Gurza is ballistically comparable to the .357 Magnum or .40 S&W auto. The Gurza is a double-action design using a polymer frame and steel slide similar to that employed by Glock and

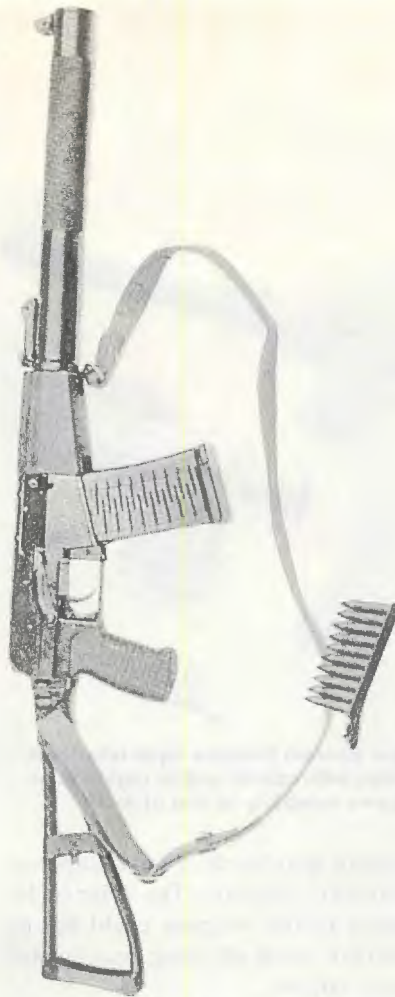

Silent Assault Rifle comprises integrated system firing special, subsonic 9mm AP round from a special-purpose weapon with integral suppressor, mounting either telescopic or image-intensifying sights. This apparently Kalashnikov-based weapon has many assemblies in common with Silent Sniper System.

the S&W Sigma. Like Glock pistols, the Gurza's frame has integral steel rails, on which the slide rides, and a magazine capacity of 18 rounds.

According to Russian press articles and the manufacturer's brochure, the Gurza will penetrate a protective vest with two 1.2mm titanium plates and 30 layers of Kevlar at a range of 70 meters. Given the high-powered ammunition associated with the Gurza, it would be logical to assume it is recoil operated with a locked breech. The Gurza appears to have a concentric recoil spring surrounding the barrel similar to earlier Russian designs such as the Makarov and Stechkin, although it bears only cosmetic resemblance to the earlier designs.

The pistol apparently incorporates several conventional technologies in novel ways. For example it has a grip safety similar to the venerable Colt .45 ACP M1911A1. The Gurza also

has an automatic firing pin lock or other type of safety device incorporated into the trigger mechanism, similar to that found on Glock pistols. Unlike the Glock, the Gurza is fired by a conventional, external hammer. The trigger safety "...is locked out when the pistol is correctly held for firing in the hand. Only when both safeties are unlocked can the pistol ... fire," according to *Red Star*. These features apparently are intended to allow the user to carry the pistol "cocked and locked" without concern about having to disengage a manual safety prior to firing.

Hot New Round

The Gurza is most significant for its ammunition performance. The bullet leaves the Gurza's muzzle at 1,378 fps (420m/s) and is claimed to penetrate most current protective vests out to a range of 100 meters. The 9x26mm round for this pistol is a new development, possibly derived from the 9x25mm "Export Mauser" round. The bullet is specifically designed to defeat body armor, but given its performance against titanium plates, it is probably effective against thinned vehicles as well.

Its closest current Western relative is probably the Swedish improved-penetration 9x19mm ammunition, but there is little similarity between the two. The dark protrusion at the tip of the Gurza's 9mm bullet is almost certainly a steel or tungsten penetrator. The Swedish 9x19mm HP penetrates 45cm (17.7 inches) of ballistic gelatin after passing through 40 layers of Kevlar at 6 meters, which although an improvement over standard 9x19mm



Ammunition technology similar to Underwater Assault Rifle makes 4.5mm Underwater Pistol effective close-quarters weapon, with lethal range of 17 meters underwater, or 50 meters above water. Featuring four barrels and double-action firing mechanism, SPP-1 is simple to load, operate.

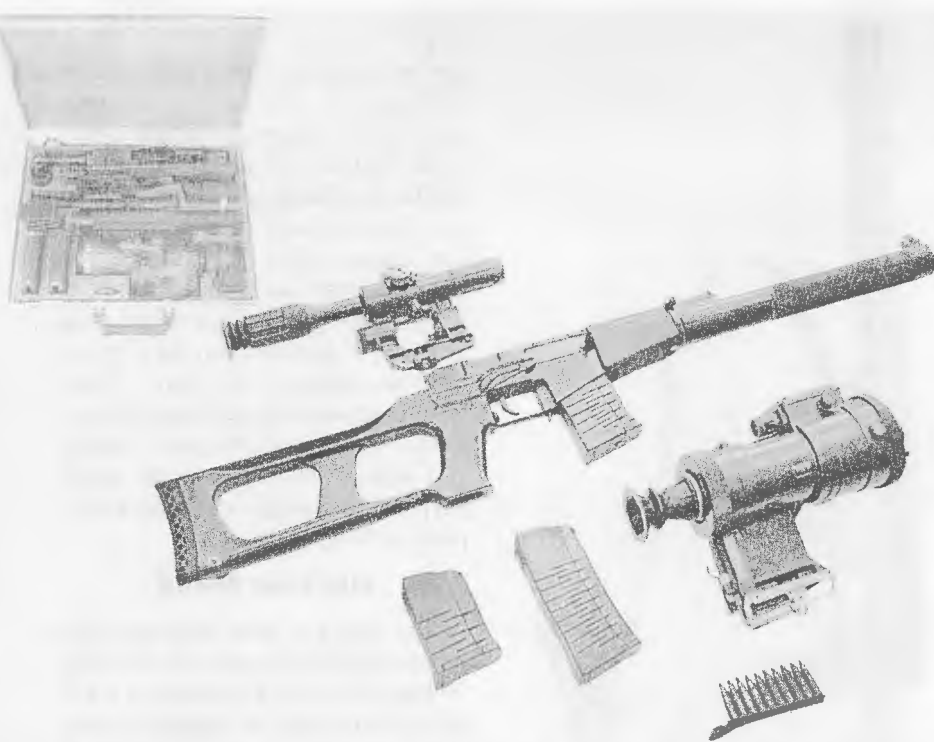

Similar to Silent Assault Rifle, 9mm Silent Sniper System features rapid takedown and stowage in standard-size attaché case (inset) with optical and/or night-vision scope, suppressor, ammo. Manufacturer compares reliability to that of AKM.

ammunition, is significantly inferior to the 9x26mm Gurza round.

A recent article in *Jane's Defence Weekly* stated the Gurza could fire conventional 9mm ammunition in addition to the 9x26mm round, but it is unusual for a pistol to fire all types of 9mm ammunition interchangeably, since differences in chamber pressures and recoil forces would usually require different recoil springs. The article further stated that the Gurza was blowback operated, but a straight blowback design is unusual in a high-powered pistol.

One of the few widely manufactured pistols that fired a relatively powerful round from an unlocked breech was the Astra Model 400 in 9x23mm "Largo." The Astra 400 also had its recoil spring concentric around the barrel, and the Astra "Condor" version with its exposed hammer bears a schematic resemblance to the Gurza. Firing a hot round from an unlocked breech requires a strong slide stop, and if *Jane's* speculation is correct, it would be interesting to know how this was engineered into a pistol with a polymer frame.

"Vintorez" & "Val" Suppressed Rifles

These rifles were shown at several international arms shows in 1992 and 1993, and limited range-firing revealed the manufacturer's claims re-

garding their levels of sound suppression were accurate. The claimed lethality of the weapons could not be verified, since all firing was against paper targets.

These rifles were designed by I. Kas'yanov, A. Deryagin, P. Serdyukov, and V. Petrov who set out to develop a complete system of silenced weapons for use by what the Russians call "special purpose subunits" (specops forces in Western terminology). The designers were awarded the "Government

Prize of the Russian Federation" for their efforts.

The "Vintorez" (Thread Cutter) silent sniper rifle and "Val" (Rampart) silent assault rifle appear identical except for stock and pistol grip, and both are clearly designed for special operations. The Vintorez differs from the Val in that it can be broken down into a compact package that will fit inside a standard attaché case. Both rifles accept the PSO-1 four-power telescopic sight, also used on the 7.62x54R SVD Dragunov sniper rifle. Both also can probably utilize the new second-generation PN-51 four-power image intensification night vision optic.

The design of both rifles is new, and while probably derived from the venerable Kalashnikov, they do not appear to be direct copies. These rifles and the A-91 9x38mm "Miniature Assault Rifle" described below appear to incorporate a modified, shorter version of the Kalashnikov gas system.

The suppressor of both rifles appears identical and fairly conventional. A video of the BA Val assault rifle being fired on full automatic was shown at one arms show, and the suppressor proved effective, reducing noise to "cap pistol" levels. How it would stand up under long-term use is unknown, but the rifle in question had hundreds of rounds fired through it, with no apparent reduction in the suppressor's effectiveness.

Retaining propellant gas and sound within cartridge, Silent Pistol System avoids bulky muzzle suppressor, has lethal range of 50 meters. Brochure notes: *If anywhere, the competition for spy's most ideal weapon has taken place, this mini, silent and comfort pistol would be its winner.*





Firing new Russian 9mm AP round, Miniature Assault Rifle is designed for optimum concealability, will penetrate double titanium plates and 30 layers of Kevlar, or 6mm steel plate at 200 meters.

Mission-Specific Round

The 9x38mm ammunition for these rifles is another new design, apparently made by “necking up” 7.62x39mm casings. In basic concept this is similar to the “Whisper” cartridges manufactured by SSK Industries in the United States. The 9x38mm round fires a relatively heavy 250-grain bullet at subsonic (950 fps) velocity, making it ideal for suppressed weapons and submachine guns.

Two cartridges are available in 9x38mm for these weapons. The SP-5 is a special sniper cartridge with increased penetration, especially for use in the Vintorez sniper rifle, while the SP-6 apparently is conventional ball ammo for the Val assault rifle and the A-91 submachine gun. The SP-5 bullets appear to have steel or tungsten penetrator tips similar to those of the 9x26mm Gurza cartridge. According to a 4 March 1994 article in *Red Star*, the SP-5 bullet will penetrate a 6mm “high-density steel plate” at 200 meters. These cartridges are also used in the A-91 9mm Miniature Assault Rifle (submachine gun) described below.

Like the other weapons discussed here, the Vintorez and Val rifles are not intended for general service use, but rather for special operations. The Russians have emphasized the armor penetration capabilities of all these weapons, and it appears they are making a serious bid for international specops forces’ business.

Miniature Assault Rifle

The A-91 is another apparently unique new design from the Russians. Although termed a “miniature assault rifle” by them, the A-91 would probably be classed as a submachine gun in the West due to its compactness. While the weapon is virtually identical in size to the Heckler & Koch

MP5A3, it fires the new Russian 9x38mm rifle cartridge. The Russians claim the A-91 can also be provided in calibers 5.45x39mm, 5.56x45mm and 7.62x39mm.

How well the weapon can be controlled on full automatic without a compensator is questionable. While the 20-round magazine capacity of the A-91 is smaller than the MP5 series of weapons, the 9x38mm cartridge, especially the SP-5 armor-piercing round, offers significantly improved terminal ballistics over any weapon chambered for 9x19mm cartridges, especially against “hard” targets. The overall effectiveness of this weapon and the others discussed herein will have to wait until a thorough evaluation is done by an independent test facility.



Adapting Western trends, new Russian 9mm Pistol System features polymer frame, 18-round magazine, double-action trigger and hot new “9x26mm” round with penetrator bullet — specifically designed for taking out personnel wearing armored vests, or soft vehicles and equipment.

Russian sales brochures clearly show that the ammo for these weapons is based on the venerable 7.62x39mm round and thus is properly designated 9x38mm. As the round is intended for use in suppressed weapons and submachine guns, it is subsonic and likely produces a significantly reduced muzzle blast when

fired from submachine guns such as the A-91.

Wet Weapons/Wet Missions

If small arms can be called “bizarre,” these two qualify. The APS assault rifle and SPP-1 pistol are specifically designed for underwater use and supposedly overcome the underwater ineffectiveness of conventional firearms. Both weapons fire a powder-propelled dart to ranges that cannot be achieved by either spear guns or normal firearms fired in water.

The APS underwater assault rifle appears to function similarly to the Kalashnikov family of small arms, but there are differences: The collapsible stock of the APS is a telescoping wire stock unlike anything previously fielded by the Russians. The rifle fires a 5.66mm cartridge designated the MPS. Unlike conventional cartridges, however, the MPS uses a 120mm long 5.66mm dart, rather than a conventional bullet.

While other developments, such as the U.S. “Flying Dragon” project of World War II and the post-war West German BUW-2 underwater pistol, used compressed gas or microrockets for propulsion, the SPP-1 underwater

pistol uses more conventional powder/projectile cartridge technology. The four-barrelled SPP-1 is manually loaded at the breech from a four-round clip. Again, this weapon is unlike anything the Russians have ever introduced. The SPP-1 appears similar in

Continued on page 67

Next Frontier For Hired Guns

Political Climate Sparks Demand for Armed Professionals in Mexico

Text & Photos by Dr. Tom Marks

Chiapas and an uprising of landless *Zapatistas* against the government and landowners was not on our minds — or anyone else's — when we accepted a security training assignment in Mexico. Our analyses of potential social instability there, were, for our clients, but ships passing in the night on a sea of far more immediate concerns.

As early as 1988 Mexico ranked as the 17th richest economy in the world, ahead of such powerhouses as South Korea and Taiwan. Growth has continued since, but with this newfound prosperity has come crime and a pressing need for security. While Mexico has boomed into the big-time, many of its people have remained on the fringes of success. This disparity, between the top and bottom of a society that is still enmeshed in revolutionary rhetoric and a form of social egalitarianism, has made crime, like everything else, a growth industry.

Crime, principally petty street crime and violent assault, was our client's major concern. Risks were highest in Mexico City and on main highways. The police themselves are apparently responsible for much of the worst abuse, being heavily involved in housebreaking, mugging, extortion and organized crime such as drug-running and prostitution.

As we were to report to our client, however, the potential for terrorism still exists. More than 67% of the population is under 30 years of age, and some 17% is illiterate. Nearly half of the potential work force is without jobs or underemployed. People in desperate straits may take desperate action. A wave of bombings in 1991 against high-profile foreign businesses, for example, was timed to gain international publicity during mid-term national elections.

These bombings did not signal the onset of an intensive campaign, but damage was caused to offices of IBM, McDonald's, and a Japanese-owned Nissan auto showroom by the Revolutionary Worker's Clandestine People's Union Party (PROCUP) and Party of the Poor (PDLP) — left-overs from rural guerrilla movements of the 1970s. PROCUP-PDLP also carried out occasional attacks in rural states. It is interesting to note that in this same time frame there were vague reports of ongoing guerrilla training in the impoverished southern state of Chiapas: These insurgents were the Zapatista National Liberation Army (EZLN), who emerged "to make a revolution" last January. But by far the greatest threat to individuals, and the issue with which we had been hired to

deal, was the growing prevalence of kidnap-for-profit. Wealthy local businessmen were the most likely kidnap victims. One of them had asked us to assess his personal security arrangements and conduct the equivalent of AIT [Advanced Individual Training] for his bodyguards.

Why us? Precisely because we were outsiders. My associate Bob McKenna, formerly of the Rhodesian SAS, and I weren't involved in anyone's games; neither were we, with our quaint military values, likely to become so-involved. Corruption simply wasn't our thing.

It is corruption, to be blunt, which is one of the

Insurance industry contacts had told us, during our preparations, that kidnapers were already holding approximately 10 important victims. These included Jorge Espinosa Mireles, a joint owner of the Printaforma computer company, and Joaquin Vargas Guajardo, director of the Multivision television company owned by his father. Both probably had been kidnapped around 12 May 1993. Reported ransom demands ranged from U.S. \$10 million to \$50 million.

With asking prices like that, we were a bargain, despite being light years away from local talent in terms of cost. There were (and are), to be sure, hundreds of indigenous security firms of varying competence. Yet most remained wedded to the "watcher" concept: that is, paying minimal wages to minimally

problems of the particular airline that had retained us. Among other problems, luggage kept disappearing. That one wasn't hard to figure out. Information put the going organized-crime reward per international flight suitcase at U.S. \$15-20, with 20 bags disappearing per 12-hour shift. Even if the numbers were off a bit, the mere fact that a baggage handler earned approximately U.S. \$400 per month, while a security guard earned about U.S. \$300 per month (and a security supervisor U.S. \$340 per month) indicated a problem. The average international flight bag would probably be worth at least a month's salary in contents, particularly if incoming.

Consequently, it was no surprise that organized crime, as well as police and security, involvement in luggage theft of all sorts appeared to be substantial. As the inside men, the airport/airline workers just couldn't resist the green dangling in front of them.

We found the same phenomenon in aircraft maintenance areas, in automobile factories, and in retail establishments — there was too great a gap between the re-

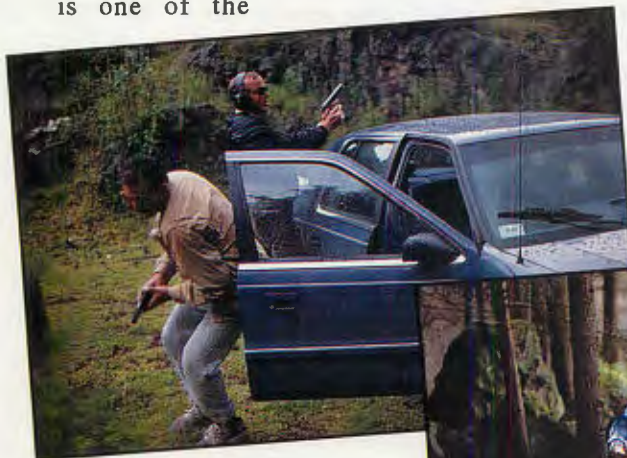

Top: Weapons instructor Bob McKenna, right, and student demonstrate how to seize the initiative when vehicle is trapped — a common ploy in kidnaps.

Middle: Settings for VIP and personal protection are not just urban, so security personnel were trained in mountains and fields around Mexico City.

Bottom: Human resources for this training mission were outstanding, such as this former Mexican paratrooper working out on pistol range. Unfortunately, this does not hold true for most local security talent.



trained individuals, frequently the very young and the very old, to park themselves at a location for "security." Certain hard points, such as banks and government offices, had better arrangements, but the weak link in even these efforts remained the low quality of the manpower.

When word of our presence got around, we were asked to do a security survey of the Mexico City airport, the cash operations of which had recently been hit (in the main terminal!) at gunpoint. *Serious* weaponry had been involved. It was one of several such major installations we were asked to assess: All, to a lesser or greater degree, proved to be victims of inadequate personnel arrangements.

At the airport, we focused on the



wards to be earned through honest work and the temptation for windfall profit through dishonest effort. Message to our clients: You get what you pay for.

In the final analysis, then, there really was, domestically, no place for indigenous clients to turn for the bodyguard training we were asked to provide. Most potential victims did not go that far. Unlike our client, who was determined not to become another statistic, most did not even have security. Their families, once the kidnap episode began, usually simply tried

greatest threats to the enormous gains Mexico has made — economically, socially, and politically.

Crime & Corruption

The authorities certainly were not oblivious to the issue, particularly where it concerned them personally. Hence they generally reacted strongly to increasing publicity dealing with kidnaps, particularly those in Mexico City itself. But they were unlikely to be able to take effective measures to curb abductions, due to apparent police complicity.

to maintain secrecy out of fear for their lives: Many cases probably go unreported altogether. Official records show that in 1991 the police solved only 16 cases out of 68 kidnappings reported in Mexico City alone.

Don't Offend The Bad Guys

The kidnappings did not generally involve violence — they did not need to — although in at least one recent instance, when the victim resisted, he was shot dead. This should have surprised no one familiar with the Latin American security environment considered as a whole, but statistically such actions are rare in Mexico. Kidnap victims did not know what else to do, in a world where everyone seemed

place of employment. The reason lies in the predictability of time and place, as well as vulnerability. In such settings, kidnappers have the initiative.

There is no foolproof method of preventing a determined assault from occurring. Precautions are intended principally to make the client an unattractive target and, if necessary, to provide a chance of fighting clear. Awareness and good information concerning the threat remain the best defenses.

To that end, we went through an intensive month. We were fortunate. The individuals with whom we worked were top-notch. Not only were their personal values sound, but their employer had carefully avoided many of the pitfalls noted above by seeing to his men's personal and familial well-being. Professionally, a dose of prior service for some — Mexico has a draft to man an army of 130,000, which includes 80 infantry battalions — combined with a good dose of smarts for all, had allowed them to learn a great deal on the job. We built upon this.

Tactical details are best left unspecified for professional reasons. Additionally, the peculiar essence of Mexican law seems to make *being* a bodyguard legal — but actually *doing* anything a bodyguard would do, illegal (such as using his weapon to foil a kidnapping). Further, certain types of equipment, while ubiquitous, remain, technically, illegal (to include certain types of ammunition).

This said, the essence of our approach would be familiar to any former adviser: set up both a technical and a physical training regimen while examining the "structural arrangements" for security. Structurally, we conducted surveys of routes, sites, procedures and personnel. Then we worked on the individual skills needed for the trainees to perform.

Extensive use of video, followed by practical exercise, proved a useful way to minimize language barriers. Technically, most of our time was

spent live-firing our way through typical bodyguard scenarios. Physically, we worked on hand-to-hand techniques that might make the use of gunplay unnecessary, then set up conditioning programs for all individuals. Throughout, we endeavored to teach principles and techniques that would be of practical application after our departure.

A point that did come up time and again was the need for the guards to be prepared for the type of enhanced weaponry presently being fielded by potential attackers. Just as guerrillas rarely run around these days with homemade shotguns, neither do serious kidnappers show up with Crossman air pistols.

Selective Standardization

Our trainees were using a variety of handguns. Marksmanship was not a problem (there was one, who we nicknamed "El Bandito," who rarely missed anything, either from fixed or quick-draw positions). What we wanted to do, however, was increase their ability to put their shooting prowess to most effective use.

Thus we recommended standardized issue of 9mm pistols, with at least three magazines per man. The 9mm Browning High Powers used by some of the guards were good, but we felt a better weapon would be the CZ-75 or Glock 17 (both also 9mm). For a

Continued on page 69



Training not to give up just because they lose their gun hand, students master the weak-hand draw and shoot.

on the take, except to give up.

From this reality had grown a peculiar psychology of defeatism within a large segment of the community of potential victims — they wanted protection, "but for God's sake, let's not do anything offensive that might upset the bad guys!" Concern has even been expressed by some potential targets that resistance could itself endanger their safety, as in the case cited above.

From our perspective, however, the bottom line was that either you wanted to be kidnapped, or you didn't. Philosophical discussions of how to surrender with grace weren't the point. There is a time for that, but the focus must be upon preparation: Proper security measures remain the best defense against nasty situations.

Statistically, worldwide, in excess of 90% of kidnappings occur while the victim is moving to and from his

Typical target illustrates level of handgun proficiency among students. All had good native intelligence and many had prior service.



Ranch Security — Mexican Style

by Douglass Norvell



The threat: Armed with revolutionary ideology and a flea-market of weapons, Zapatista rebels set up roadblock between San Cristobal and Ocosingo in southern Mexican state of Chiapas. Aside from imposing a "war tax" on tourists, Zapatistas "taxed" local ranchers all the cattle they could rustle. Photo: AP/Wide World

Take a flight to Tuxtla Gutierrez, a city the size of Minneapolis and the capital of southern Mexico's state of Chiapas, and within a two-hour's drive from the airport you can be in the heart of a no-man's land where the only law is a Ruger Mini-14, the favorite weapon of Mexico's besieged ranchers.

The cattlemen's security needs recently escalated when the forces of the Clandestine Revolutionary Committee of the Domestic General Command of the Zapatista Army for National Liberation (aka Zapatistas) came boiling out of the jungle shouting "Land and Liberty!" in the manner of their predecessors who followed Emiliano Zapata 80 years ago. While liberty is there for the taking, unfortunately the land belongs to someone else: namely, ranchers who have run cattle on family spreads for as long as five generations.

The situation largely parallels Rhodesia in the 1970s, when tribal-culture, landless, have-not rebels sought to "redistribute the wealth" by commandeering what settlers and ranchers had built. Debates of whose great-great-grandpappy robbed whose land aside, hard-working ranchers are as universally disinclined toward largess for those they regard as indolent as they are to abandoning their ranches in the face of drought, flood and pestilence.

In the first phase of the "liberation" operations, rebels-turned-rustlers opened gates and herded cattle off to mountain pastures. *The Miami Herald* reported that one rancher in Altamirano had his entire herd of 25 cattle seized by the Zapatistas. Another lost 90 of 250 cattle, and yet another lost three horses and 20 cattle. In Mexico, where food is more expensive than in the United States, a mature bull will bring about \$1,000 at the local auction, where buyers from Mexico City haul them off to feed the world's largest metropolis.

As food suppliers, ranchers expect to receive protection from government

troops, but the strong response ranchers expected in the face of the Zapatista revolt failed to materialize. Instead, after quelling the uprising with army troops, the government waffled and sent a team of negotiators and counselors, then replaced the dreaded *Federales* with a strictly defensive military police detachment. While urban centers and tourist facilities are heavily guarded, the countryside and ranches are part of a "no fire" zone, which means there are no troops to keep the peace and ranchers are left to fend for themselves.

Fending for themselves means expansion of the *Guardia Blanca*, or "White Army," composed of ranch hands and private paramilitary personnel. In light of the conflict and government indecision, ranchers have increased their private security forces to an all-time high. Human-rights organizations put the size of the White Army at 9,000 strong. Typically, the larger ranches will maintain a security force commanded by a "jefe," often a retired national police officer, who gets between \$600 and \$1,000 per month, plus perks such as the use of a pickup truck. The "jefe" is backed

Continued on page 70



The response: Private security guard carries pump shotgun, a favorite among locals on both sides. Mexican military and police organizations concentrate on quelling rebellion and protecting the government — leaving commercial entities and individuals to fend for themselves. Photo: Douglass Norvell

Charlie Sell

Hanoi Hustles Spoils of Vietnam War



Some items are rarer than others. This was the only CH-47 Chinook seen during tours of Bien Hoa and Tan Son Nhut air bases, though replacement engines were plentiful.

former military and showed some wariness about us, but one bottle of Johnny Walker later (they prefer red label over black!), they told us to be ready in the morning.

Rest At The Rex

We checked in at the old Rex Hotel on the corner of Le Loi and Nguyen Hue. It's had a face-lift inside and out, yet isn't too pricey. There, one has the advantage of single rooms, private baths and hot water. And one more thing: They have safes in every room — a big plus.

I quit smoking years ago, but I always carry four or five packs of Marlboros with me in Asia. It continues to astound: the irregularities and inconveniences that the Marlboro Man can rescue one from. I heard he died last year. Too bad, but then all my heroes died young.

I opened a pack, lit one, and set it on the ashtray while I showered. When I finished dressing, I went back for the smoke. It had burned halfway before dying out. I took the stub and opened the zippers on my bags, using the filter tip as a gauge for the set: too

In front of us were 84 U.S. Army Huey helicopters in three rows, shoulder-to-shoulder, looking a bit spooky, as though they were sitting there in the afternoon sun waiting to gas up, crew up and go. After all, this was Bien Hoa Air Base, north of Saigon. But it wasn't 1969 — it was *now*.

A week earlier, I had gotten a call from an old Thai friend, Prapat. We'd done some parts business with the Thai army and air force, and he asked me if I knew what an F-5 Freedom Fighter, A-37 and A-1E Skyraider looked like. I told him I'd flown the first two and knew a good deal about the A-1 as well. He then asked if I'd like to go with him to Vietnam to look over some airframes. I told him the word was out that those machines were in bad shape, having sat for 20 years in the rain. He assured me that these were in decent shape and asked if I knew a helo expert, because they also had a mountain of spare

A-37 fighter/bomber ready for inspection. Though rumored to be in bad shape after more than 20 years of storage, many of the abandoned U.S. airframes are serviceable and bargain-priced. Inset: Most still carry their wartime armament such as this General Electric mini-gun.

parts for sale. When Prapat told me that much of the gear was brand new and available at less than 10 cents on the dollar, I was hooked. I called an Aussie buddy of mine nicknamed "Croc." Croc had been an A&P (airframe and powerplant) mechanic on Bell choppers for 15 years and could fieldstrip one in the dark.

It took three days to get a visa and together the three of us flew to Saigon (nobody, not even the Vietnamese, calls it Ho Chi Minh City). We were met at the airport and spent an hour at the government office set up to verify our credentials. The Vietnamese officials were all

s Choppers

Text & Photos by Will Cadence



small an opening for a hand and easy to measure when I got back. Then I tamped the ash from the ashtray, opened the safe and sprinkled some around the corners of the envelope that held half my bankroll. *The war has been over for two decades, but old habits die hard.* I strapped on my money belt and went upstairs for dinner.

Prapat and Croc were already into their second beers when I sat down. We ate and drank for about an hour and a half. It took a mess kit full of inflated Vietnamese *dong* to pay the bill, and then Croc wanted to check out the bars. I begged off and headed back to my room, feeling no pain. When I turned the light on, I did have the presence of mind to check my traps, and low and behold the room had been swept. The zippers were close to my set, but the filter tip gives an exact measure and they were off, ever so slightly. I checked my bag and when I found my checkbook in one of the side pockets, I really felt clumsy. I don't get to use my U.S. checks too often, and these checks still

A1 Skyraiders served admirably as American counterinsurgency aircraft during the Vietnam War, often providing pinpoint accurate ground support at the critical moment. This "H" model sitting at Bien Hoa is in good enough shape to fly again.

had my old rank listed next to the name from my *active* days. I wondered if they were smart enough to pick up on it, until I flipped through the checks and saw that the last one was missing.

The next morning, Prapat was given the word that the visit was off. He hit the ceiling and stormed out. Two hours later, he was back. The Viets figured I was U.S. intel out to

inventory their cache, so that Uncle Sam could make it part of the normalization process. Prapat told them I was long retired, and "who else but a former GI would be able to inspect their equipment?" His logic must have worked because an hour later a van arrived and we headed for Bien Hoa.

Déjà Vu And Mini-guns

Among the first things I spotted was a Huey halfway down the line with a 1st Cav shield-and-horse on the nose. The mini-gun was still there,

pointed out the door. I climbed past the weapon and slipped into the pilot seat. Most of the instruments were still in place. The clock was gone, and the attitude indicator had been removed. Then I felt something move. I snapped my head around. Up above, through the green window, I saw it—the main rotor blade. It was swaying up and down in the breeze, its shadow moving across the cockpit floor. My heart was knocking sledgehammer blows at the temples. *Eerie!*

Croc found 10 airframes out of about 30 he checked that were in good shape, "better than most of the overhauls I see come through," he said. Then we were escorted to another part of the base where they had the F-5s, A-37s and A-1s. We crawled all over them the rest of the afternoon. The planes still had all armament including mini-guns, cannons and bomb racks. Several of the jets still had full instrumentation. Some showed varying levels of corrosion, but there was definitely enough left to put together a decent airplane or two, especially the A-1Es and Hs. There were 13 of

Our guide then asked, "Y AK-47, Colt .45, gren



In the adjacent building, we saw more than 50 containers: Each one had a T-53-L13 Lycoming engine inside.

them, complete except for cockpit instruments. We pulled the tail off one and took a peek inside. No corrosion. There was some pitting on the gear struts, but no major deterioration. This was interesting stuff, but Croc wanted to see the new parts and equipment for the Hueys. "Tomorrow," our military escort said. "No more time today."

That evening we discussed arrangements at the Apocalypse Now saloon while Robin Williams wailed *"Good Morning, Vietnam!"* from the video above the bar. The town was rocking with retired GIs, French and Vietnamese women. A retired O-6 told me, "They don't hassle us here, and you can live like a king on what's left over after your ex gets hers." He went on to warn me that the hospitals are a crime against medicine — they don't have any. "If you get sick, take a cab — directly to the airport!"

The feeling that night was absolutely surreal.

As promised, the next morning we were escorted back to Bien Hoa. This time, we went to a large, dilapidated building away from the aircraft. The

Warehouse full of Lycoming T-53-L13 chopper engines stored in their protective containers since the end of the Vietnam War. Inset shows an opened container with engine in like-new condition.

light was dim inside, but there on the floor was a sampling of the parts available. Each item was in a shipping box or wrapped in protective foil. There were 45- and 90-degree gearboxes, main drive shafts, aft rotor hubs and main rotor grip/yoke assemblies that had never seen the turn

of a blade. All items had new issue-tags or yellow tags (used/ repaired). Croc inspected the items and gave them a thumbs up.

There were olive-drab crew doors still wrapped in brown shipping paper, "green" windows, wind screens and chin bubbles with protective tape still in place, and tail-rotor blades with new tags. We were allowed to inspect every item. Croc checked the serial number on one rotor head. It was spanking new, with a light covering of grease. He spoke to me in Thai. "No good, this one's been superseded by a modified part. It's worth only 10% of the price of a new one." Other items were still current issue, worth every penny of the wholesale/retail price.

Croc began his inspection. He removed a plate from the right side and inserted a widget to turn the gearbox. "Dee lao," he said (perfect). The engines were not new, some showed light corrosion from exposure to the damp air, others showed no sign of deterioration at all. Price? They would accept \$10,000 for each one. An overhauled T-53 runs about \$300,000 a copy. Some engines had no logs, which meant that parting-out would be the best option for these — still a good bargain (a new bellmouth runs in excess of \$75,000).

You Want, We Get

The Vietnamese claim to be able to deliver practically any quantity of a desired item, once a deal is set. When Prapat mentioned he did not want to deal in cash, they said, "No problem, you can make a bank transfer from your bank in Thailand to our account in Saigon." The transfer would be verified at the port of embarkation and upon inspection of all purchased items. They were prepared to package everything on-site and load it onto trucks or flatbeds (under buyer supervision). Everything would be taken to the port and shipped to the buyer's

ou need any tanks or M16, grenade launcher, ammo?"



There are hundreds of U.S. Hueys in Vietnamese hands, along with the parts needed to keep them flying — and it's all for sale, cheap.

This work requires some skill and knowledge — not something you'd want an entry-level Vietnamese wrench-turner to try.

That night we went bar-hopping. The old Saigon River section still sports the one-room beer joints replete with bar girls whose warm hands are ready with a back massage while you quaff a few Heinekens or San Miguels. The girls mentioned that from time to time, the local authorities shut things down if it gets too noisy or the payoffs come too slow. *Nothin' ever changes!*

The next day we went to Tan Son Nhut Air Base and visited a covered storage depot in one of the supply areas. On one side they had old Russian equipment in wooden boxes, but on the other it was like Sears Roebuck & Co. Here we saw metal containers with T-55 (Chinook) engines, transmissions for Hueys and CH-47s, along with J-69 (A-37) and General Electric J-85 (F-5) jet engines. There were 29 Pratt and Whitney R-3350 recip engines for both the A-1E/Hs and C-123s and some R-2800s for the C-47.

destination. A-1s would require wing removal (at the wing fold) in order to get them under various electric wires and across a bridge or two.



The engines still had logs and most had been overhauled in Taiwan — 21 years ago. Most moisture indicators still showed dry status, but one container had taken a few rounds. I looked through one hole while shining my flashlight through another. The engine was there, all right, looking none the worse for wear except for a ding on one cylinder where a round had ricocheted off. Five thousand U.S. buys any R-3350 overhauled engine. They also had C-123 and C-130 parts, but we didn't feel qualified enough to sort the good from the obsolete. Our guide then asked, "You need any tanks or M16, AK-47, Colt .45, grenade launcher, ammo?"

Back in town that afternoon, we went to the local "flea market." Bingo! We found where the cockpit instruments had gone. I bought a Huey EGT (exhaust gas temperature) gauge for \$4. The seller hooked it up to a thermocouple to show that it worked. A voltmeter that tested good went for

Cockpit of UH-1 shows some instruments missing, but typically few parts or instruments have been cannibalized. Those that are missing can often be found in the "flea markets" of neighboring villages.

\$9 (the logic is that it has more use than a helo EGT gauge). Two good eight-day clocks went for \$10 apiece (same logic as above), and two brand new cylinder-head temp gauges for an A-1E went for \$10 — the pair. These still had the protective copper shorting wire installed. Back in Bangkok, the EGT gauge was placed on the test bench and it operated within one degree of all test points (0-1,000 degrees), qualifying for yellow tag status. A new gauge lists at \$2,685.

Naturally, the Bell Helicopter Co. would rather not see any of these parts back on the market — and in some cases for very good reason. But once a part goes through the requalification process, it's as good as any other part made by Bell or its subcontractors. These are milspec parts.

To The Victor ...

But what does Uncle Sam say about all this? I checked, and the U.S. government has no further claim to the "spoils of war." In other words, the goods belong to the Vietnamese. During the embargo, U.S. citizens could

Continued on page 63



SWITCHBLADE - AUTOMATIC KNIFE COLLECTORS

The Automatic Knife Resource Guide and Newsletter

A unique publication for the automatic knife enthusiast, NOW in it's THIRD YEAR! Terrific photos, in-depth articles, maintenance and repair tips, the LATEST trends, resources for ALL kinds of automatic knives, free classified ads and MORE! Send \$10. for single issue or \$30. (\$36. Foreign) for one year [4 issues] subscription to: "THE NEWSLETTER" 2269 Chestnut Street, Suite 212-A, San Francisco CA 94123, USA, Phone/FAX: 415 731-0210.

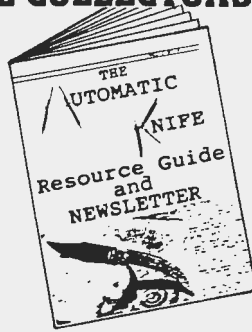

I WAS THERE

Continued from page 15

the patrols I rounded a curve in the road and — surprise — the regimental commander approached on his way back from Seoul. He stopped his jeep and looked at the waiting trucks and the troops who were climbing aboard. "What's going on?" he asked.

"We're completing a search mission, sir. It's kinda complicated, but ..." There was no way I was going to lie to the man. If you tell the truth you'll probably get your ass in a sling, but if you lie to a superior officer and then get caught later, you won't have any ass left!

"Horseshit! Tell me later, I'm freezing my nuts off!" With that he motioned his driver and they roared off in the direction of Sok Cho. Fortunately for me, the whole thing died and was never brought up. For all I know, the Mah-Yang tearoom is still there, alas, minus Miss Kim. ✕

STEROIDS

D-BALL TEST JET DECA

Anabolic Steroids build Muscle Mass and Strength
Now there are safe and effective replacements for steroids
PRO BODY® Power Formulas

Leading Steroid Replacer

Huge gains in muscle mass and strength have been reported from Boron users. Completely legal and no side effects. Gains won't be as good as with steroids for most, but response is great and lifters are coming back for more. The extra edge. Boron.

BORON 3 month cycle #55001 \$17.95

The Real Thing - Dibencozide

Dibencozide has proven Anabolic effects. Gain Weight. Get Strong. Fast Recuperation. Guaranteed. The problem is that a lot of the Dibencozide out there is not real. PRO BODY Dibencozide is the only one that comes with a copy of the lab analysis that proves it is 100% real. Get big today. **DIBENCOZIDE** 90 caps 10mg #55006 \$34.95

Build Mass and Lose Fat

Human Growth Hormone increases lean Mass and decreases body fat. The ingredients of GH Power Formula have been proven to naturally increase Growth Hormone levels up to 700% in 90 minutes. GH levels still 300% higher 8 hours later. Get the hard look with GH Power Formula. **GH POWER FORMULA** 90 tabs #55024 \$24.95 **GH POWER FORMULA** 180 tabs #55025 \$44.95

the ultimate Mass Formula

Get big now. Combine all of the best Power Formulas for Ultimate gains. Boron, Dibencozide, Yohimbe, Smilax & Amino's in a huge 60 day cycle. Guaranteed Size. Get it all with the Mass Formula. At a 30% savings. **MASS FORMULA** 60 day cycle #55050 \$89.95

All PRO BODY Power Formulas are 100% GUARANTEED or your money back

FREE CATALOGS

CALL 1-800-962-4769 ask for dept. #623

FAST SHIPPING

Toll free - 24 hours - 7 days

Send to: JTR Labs - 10230 Bach Blvd., Dept #623 - St. Louis, MO 63132

For questions and local orders call 314-426-7040

RUSH ORDER FORM



Name (as on card) _____

Address _____ Apt.# _____

City _____ State _____ Zip _____

Phone#() _____

Card# _____ Expires / _____

SEND TO: JTR Labs
10230 Bach Blvd. - dept#623
St. Louis, MO 63132

| PRODUCT | ORDER# | QTY | PRICE | TOTAL |
|-----------------------|--------|-----|-------|-------|
| | | | | |
| | | | | |
| | | | | |
| SUB TOTAL | | | | |
| SHIPPING | | | | 4.00 |
| Missouri add X .05725 | | | | |
| OTHER | | | | |
| TOTAL | | | | |

-IMPORTANT ORDERING INFORMATION
-Foreign orders add 25% of total in US funds
-Fedex 2nd day air add \$5.00
-COD orders add \$4.00
-AMEX must be shipped to billing address
-Dealer inquires welcome

COMBAT WEAPONCRAFT

Continued from page 19

those used to turn house lights on and off. Set the timer for five minutes and relax. Initially it is best to perform this drill standing, adding sitting, reclining, and other positions of unreadiness as you progress. Don't anticipate the sound, simply relax and be "un-ready." When the sound "startles" you, force yourself to go to the grip step of the draw. Do this in a strong, positive manner. At first you will notice that there is greater lag-time than when you are "ready." Don't worry, because the more you practice the less your lag-time.

The key to this drill is to let the sound you've recorded actually startle you, in order to program the proper response under realistic conditions. Vary the recording you use to avoid becoming accustomed to one sound. After you have performed this drill the desired number of times, practice

several full and complete draws to reestablish the entire combat response in your mind.

Converting the startle response into a tactical response also tends to replace fright. The grip of the draw is a very forceful and positive action that tends to remind you of the skills that you have learned and focuses the mind in the "right direction" during an unscheduled social disagreement. What follows is usually life-saving concentration on sight picture and trigger press.

I remember a conversation with a senior police officer, a Medal of Valor winner who had won a gunfight against three armed robbers. He told me he was so busy sighting and shooting, he didn't think about the possibility of being killed.

Cooper says that under such circumstances the marksman will not think about fear or fright — not from courage, but because he is so busy thinking about shooting, there is no mental room for anything else. Aggressively going to "grip" will overshadow the startle reflex and set the tone for the rest of the fight.

If you develop a tactical response to the startle reflex, you will never act surprised — even when you are.

A full-time police officer in Southern California, Gabriel Suarez trains within his department and for civilians through the Front Sight Training Institute in Aptos, California. ✕

CHARLIE SELLS CHOPPERS

Continued from page 61

not buy and ship these items through U.S. customs — they would have been confiscated. But there is no restriction on a Thai or Singapore or Hong Kong company purchasing items, and storing them in those countries until the vagaries of the newly lifted embargo are sorted out. Now that the embargo has been lifted we can expect a great deal more activity; when I was there, there was already a good deal of equipment moving out of the country, and

WHEN YOUR TYPICAL DAY ON THE JOB IS ANYTHING BUT TYPICAL.

LONDON BRIDGE TRADING CO. IS A *manufacturer* OF TACTICAL LOAD-BEARING AND OTHER SPECIALIZED EQUIPMENT FOR: BUILDING ENTRY, SNIPER/COUNTER-SNIPER, SURVIVAL, ESCAPE AND EVASION.
OUR GEAR IS USED WORLDWIDE

BY MILITARY SPECIAL OPS UNITS, GOVERNMENTAL AGENCIES AND SPECIAL LAW ENFORCEMENT UNITS. RETAIL AND WHOLESALE ACCOUNTS.
Send \$2.00 for our extensive catalog.

STORE HOURS: M-F 9:00-7:00.
SAT. 12:00-6:00. • 804-498-0207



LONDON BRIDGE TRADING CO. LTD.

3900 BONNEY RD., STE. 107
VA. BEACH, VA 23452 USA

1-800-229-0207
FAX 804-498-0059

The Ultimate Security System



High-impact RED decals declare your right to bear arms and your willingness to use them!

- Place these high-visibility, high-impact RED decals on your property. (Home, Car, R.V., Boat . . .)
- Let would-be burglars know that you are willing and able to stop them "dead" in their tracks!
- Powerful, cost effective way to deter crime and show support for your 2nd Amendment right.
- Red background, white lettering, black gun as shown above. Package of five decals only \$14.00, plus \$1.00 shipping and handling.
- Also available logo T-Shirts and caps. T-Shirts, 100% cotton. Sizes L, XL and XXL. Cotton caps, one size fits all. Both available in black w/ white logo. Each item \$13.00, \$2.00 shipping and handling.

Send check or money order to:

2ND AMENDMENT SECURITY COMPANY
2250 N Rock Road, Suite # 118-158
Wichita, KS 67226
(316) 269-7905



Package of 5 decals (\$14.00, plus \$1.00 shipping and handling) Number of packages _____

2nd Amendment T-Shirts (\$13.00, plus \$2.00 shipping and handling) Quantity _____ Size(s) _____

2nd Amendment Cap (\$13.00, plus \$2.00 shipping and handling) Quantity _____

Money Back Guarantee

Please print _____

Name _____

Address _____

City _____

State _____ Zip _____

Phone _____

Reticle #22

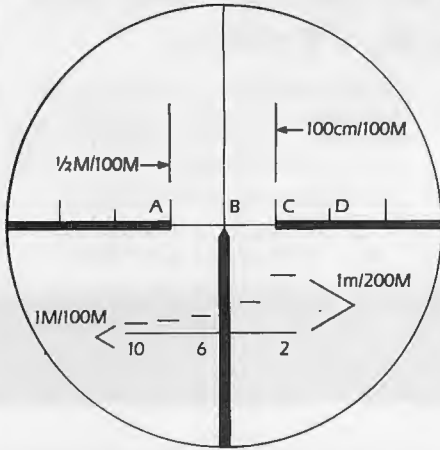

NOTE: cm/M drift and elev. info. does not appear on reticle.



KZF 84 MILITARY RANGEFINDER RIFLESCOPES

- * 6 POWER OR 10 POWER
- * BALLISTIC CAM SYSTEM
- * NATO SPECIFICATIONS
- * OTHER RETICLES AVAILABLE

SPECIAL FFL PRICING AVAILABLE

Kahles USA

PO Box 81071, Warwick, RI. 02888 Tel. 1-800-752-4537

all I saw was the tip of the iceberg.

Some pointers for those who may feel inclined to go on a shopping trip:

- The Vietnamese are tired of window shoppers. Buyers must know what they want to see and be prepared to examine and make a purchase offer. If a buyer says he'll get back with an offer later, they will ask you to leave town. When "later" comes, that particular lot may have been sold and you're back to square one.

- Take a flashlight, tools, and bring an expert to check each item. Due to specification changes, some parts can no longer be installed on an airframe without incurring significant operating limitations. Let the buyer beware.

- Do not bring large amounts of cash in-country, but do bring enough to cover all expenses. U.S. credit cards were not honored during the embargo. Foreign credit cards are honored.

- Buyers are expected to transfer cash from an out-of-country account to Vietnam.

- Do not buy and store purchased goods in Vietnam. When it comes time to ship, you may discover your items have been sold — again.

- Expect your hotel room to be swept. Mine was, and it complicated things when they connected me to my prior service.

- Do not discuss prices or any business details in hotel rooms or business offices. Every hotel employee is debriefed *daily* by the local intel section-chief.

- U.S. embassies around the world can provide the latest embargo status upon request. They will even fax you a current circular if it's a local fax number.

- Secure import approval ahead of time for any commodities you wish to bring back to the United States: Although the trade embargo has been lifted, rules against reimporting any military items originally exported as part of a foreign assistance package may apply.

When we landed back in Bangkok, Croc turned to me, "Say mate, when was it that feller found the gold in California?"

"Forty-nine," I said.

"That a fact? You know something, mate? It feels like forty-eight-and-a-half 'round here."

A former military aviator, Will Caddence is now a California-based writer and entrepreneur. ✕

TITANIUM

"The COMPETITIVE edge..."™

\$34.95 Fits AR-15 & M/16 style Rifles

\$21.95

Fits 1911 pistols
.45 ACP &
.38 Super



You have already discovered the advantages of our Titanium Firing Pins for 1911 pistols. **NOW YOU CAN ADD THE SAME MAGIC** to your competition AR-15® & M/16®.

Improve scores, reduce slam fires, discover what **QUICK** really means!
Cut lock time . . . & get on to the next target!

Proudly Made in the U.S.A.

Retail order desk:
1-800-444-1911
(Add \$3.00 S/H per order)



Quality Machining
INCORPORATED

"OUR NAME SAYS IT ALL"™
P.O. Box 129 • Sherwood, Oregon 97140

24 HOUR FAX LINE FOR ORDERS & DEALER INQUIRIES: 1-503-590-8530
(Product Information: 1-503-590-3636)

FAST-ROPE INTO HELL

Continued from page 45

began to play cat-and-mouse with the Americans; probing, but never assaulting their positions. Whenever they did mass, even if only in small groups of two or three, Bray would call in the gunships. Most of the missions were "Danger Close" — within 10 yards, and they were devastating.

Once the assault element of Task Force Ranger returned safely to the airport, the gunships that rode shotgun with the convoy were able to turn their full attention to the CSAR team.

Around midnight, the building where Fales had moved the wounded began taking a terrible beating from RPGs.

"It was literally coming apart," said Fales, who asked Al Lamb, the demolitions expert, to blow the rear wall into what Fales thought would be a stronger building. Although there were 10 wounded soldiers inside the tiny room when blocks of C-4 exploded in a blinding flash, no one was injured. The blast blew all of the rubble into a courtyard — a dead-end courtyard! But with a little more C-4, the Rangers blew themselves into another house where all the casualties were consolidated.

Somalis Go For The Kill

The respite was only temporary. The Somalis moved a 12.7mm heavy machine gun across the street and started punching holes through the walls. Tracers lit up the darkened room like strobe lights, and every time one flashed through the room, Wilkinson could see someone diving for cover. Bray put an end to the light show when he called in a rocket attack by helicopter gunships. Despite the expenditure of enormous amounts of ordnance in a tightly confined area, there were no friendly fire casualties.

About 0100, Fales, Wilkinson and Bray heard the sounds of battle getting ever closer to their location.

"We knew they (the Quick Reaction Force) would eventually come back for us," said Fales. Alpha Company of the 2nd Battalion, 14th Infantry, a unit that arrived late after the Battle of the Little Big Horn more than 100 years ago, finally fought its way through all the barricades and ambushes to the CSAR team, thanks in part to four Pakistani tanks and 28

THE FIRST TEAM



Safari Arms, INCORPORATED

620 - 624 OLD PACIFIC HWY SE • OLYMPIA, WA 98513
TELEPHONE (206) 459-7940 • FAX (206) 491-3447

Carry-Comp .45s now available from **Safari Arms** — with the Wil Schueman-designed hybrid compensator system. Adds no length or significant weight to the pistol, yet drastically reduces recoil. **Right:** Matchmaster and Enforcer Carry-Comps

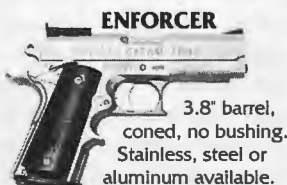

ENFORCER

3.8" barrel, coned, no bushing. Stainless, steel or aluminum available.

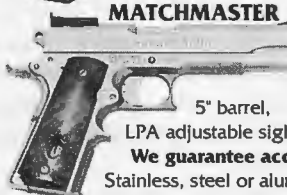

MATCHMASTER

5" barrel, LPA adjustable sights. **We guarantee accuracy.** Stainless, steel or aluminum.

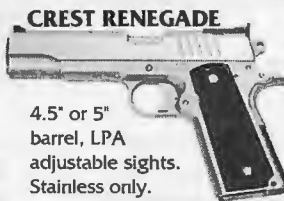

CREST RENEGADE

4.5" or 5" barrel, LPA adjustable sights. Stainless only.

At last! A custom quality left-handed .45 ACP at a reasonable price for **LEFT-HANDED** shooters. Tired of catching hot brass in your teeth? Try the **RENEGADE!**

Popular Magazines of the World

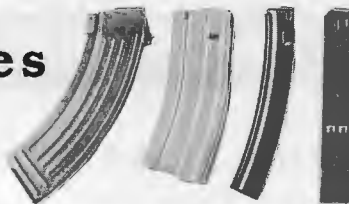

AK47 M16 MP5 UZI Machine Gun News



Machine Gun News — the indispensable magazine that contains information not found in other firearms publications. **Machine Gun News** keeps you informed about the status of federal firearms laws, rulings and bans, and the effect these laws will have on ownership. Plus, every issue features

an arsenal of information including in-depth articles and reports on machine guns, suppressors, and semi-autos. Whether it's differences in parts, sources for magazines, or functioning problems **Machine Gun News** brings you solutions. It is a unique firearms magazine that never runs out of ammo.

Special 7th Year Anniversary Offer

The regular yearly subscription price is \$34.95. But, for a limited time, you can have a full year's subscription (12 issues) for only \$29.95. Complete the coupon below or call 501-525-7514 and subscribe now!

Yes! Start my subscription to Machine Gun News. I'll receive 12 information-packed issues for just \$29.95! (Offer good in U.S.A. only. Foreign subscribers send for rates.)

M/C, Visa, AmEx #

_____ Exp. _____

Check/Moneyorder enclosed

To ensure your privacy **Machine Gun News** is mailed with a protective cover.

Watch for your first issue in 4-6 weeks!

name _____

address _____

city _____ state _____ zip _____

Send to: Machine Gun News
P.O. Box 759, Dept SFP,
Hot Springs, AR 71902

Or call: (501) 525-7514

Fax order line: FAX5015257519



Malaysian armored personnel carriers. But the linkup took three more hours to accomplish.

"As the troops swept past us, the volume of hostile fire dropped off to practically nothing," Fales said. It was only then that efforts were made to remove the pinned pilot from the wreckage of Super 6-1. It took metal-cutting saws and a Humvee with a tow strap attached to the wreckage before the pilot's body could be pulled free.

Charlie Company of the Quick Reaction Force, which had to retreat to the airfield after being repeatedly ambushed as it tried to reach Durant's downed Blackhawk the day before, finally reached the crash site. But there was no sign of the crew. Durant had been captured, and the bodies of the other five crewmen would later be desecrated: one of them dragged through the dusty streets of Mogadishu in his skivvies.

Extraordinary Heroism

Fales was awarded the Silver Star for continuing to treat other wounded men while tending to his own injuries. Bray was awarded the Silver Star

for subjecting himself to hostile fire while verbally guiding air strikes on Somali militiamen trying to overrun their position.

Wilkinson, without regard for his personal safety, grabbed medical gear from the downed helicopter and dashed repeatedly through heavy fire to treat several Rangers who were wounded. He was awarded the Air Force Cross for "extraordinary heroism," and is one of only two active-duty enlisted members of the United States Air Force who wear America's second highest decoration for valor.

Wilkinson's team didn't lose anyone, but it took heavy casualties. Five or six were hammered hard, including Fales who was shot in the leg. And the rest, including Wilkinson, will spend the remainder of their lives setting off metal detectors in airport security lines — their bodies were perforated with shrapnel from RPGs. Fortunately, the Somalis must have acquired a bad lot of Russian grenades. Fales and Wilkinson only remember one detonating, although there were plenty of duds lying around after the firefight ended.

Was Operation Restore Hope, as

President Bush dubbed the humanitarian mission, worth the lives of 39 U.S. servicemen? The answer to that depends on who you talk to. Some U.S. servicemen are glad they went. Others are disappointed that Aidid is still in control.

Wilkinson said, "It's hard to justify the loss of your friends." But neither Wilkinson nor Fales is bitter. "We had nothing to do with international politics," Fales said. "And if we hadn't been there, more Americans might have died," Wilkinson added.

Amen.

At this writing, Sergeant First Class Randall D. Shugart and Master Sgt. Gary I. Gordon, Green Berets assigned to Headquarters and Headquarters Company, U.S. Army Special Forces Command, Fort Bragg, North Carolina, are being processed for posthumous awards of the Medal of Honor. Shugart and Gordon died trying to save Durant.

A senior SOF Foreign Correspondent, Dale B. Cooper has provided numerous first-hand accounts of the American military in action. ✕

AMERICAN-MADE NIGHT VISION FROM EXCALIBUR! New Product Low-Price Blowout!

Miniature Night Vision POCKETSCOPE Model 499

New with Factory New Image Tube
Operates on "AA" Batteries

MODEL 499

\$1995.00

Plus Shipping

ALSO GEN. III Units
at \$2995.00



US Army Style Dual-Tube NIGHT VISION GOGGLES

New with Factory New Image Tubes
Operates on "AA" Batteries

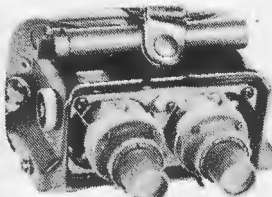

(GEN II)
MODEL 799
\$2995.00
Plus Shipping



(GEN III)
AN/PVS-7B
\$3995.00
Plus Shipping

FFL DEALERS CALL FOR
SPECIAL SAVINGS & NEW PRODUCTS!

EXCALIBUR'S GUARANTEE

1. These night vision products are manufactured using the finest in NEW components and image intensifier tubes.
2. Our image tubes are MADE IN THE USA by a major manufacturer of night vision systems for the US Military (no Russian surplus).
3. Our systems are WARRANTED for TWO FULL YEARS.

EXCALIBUR ENTERPRISES, P.O. BOX 400, FOGELSVILLE, PA 18051-0400

(610) 391-9106

Call for FREE Product Listing
or send \$4.00 for complete catalog!

(610) 391-9223

RUSSIA'S SECRET WEAPONS

Continued from page 53

basic concept to the 19th century Sharps Derringer or the Mossberg "Brownie" pistol, which also had four barrels and fired each cartridge sequentially via a rotating firing pin. The pistol is strictly manual in function, unlike the underwater rifle, which is apparently gas-operated. The SPP-1 pistol dart projectile is 4.5mm caliber.

Both of these weapons are obviously highly specialized. If their actual performances measure up to the manufacturers' claims, these underwater weapons offer special operations forces a unique capability.

All in all, these weapons show a remarkable level of technological innovation by Russian small-arms designers. Each is a "system," which appears to integrate weapon and ammunition performance unlike any prior Russian small arm. The Russians are anxious to export all of these weapons, as evidenced by their displays at

virtually every major international arms show since late 1992 and policy statements by senior Russian officials.

Whether these specialized weapons will make their mark in the Western specops community remains to be seen. At any rate, these firearms clearly demonstrate the Russians are at the leading edge of small-arms design and are capable of innovative, technical solutions to specialized requirements. ✕

LAP DOGS LEAD WAY

Continued from page 35

got it right on all five counts.

The post-Cold War military is besieged with serious problems. Yet no one at the top has had the guts to sound off and tell the truth about these time bombs. To do so would be a career killer and there's always that other star or plush defense-related job waiting after they check out to cash in.

Tailhook would have ended before the first gauntlet had been run if

the brass who were there had the balls to stop the high-school locker room antics on the spot. According to 12 witnesses and a Navy judge, the Navy's chief sailor — Admiral Frank Kelso — was there and saw what happened; but he claims he didn't see anything.

After the fact, when all the shit was coming down and Pat Schroeder, the biggest threat to national security since Hitler, was having a field day, it would have only taken some of the brass saying, "It happened on my watch. I'm responsible. Here's my resignation." Such forthright admissions would have sunk the Tailhook scandal before it built up the steam to clobber the Navy.

1 In 1,000

So far, only the previous Secretary of the Navy has had the courage to go down with the ship, while top Navy brass have scurried for flotsam to cling to. Had Nimitz been running the Navy, Tailhook wouldn't have sunk our proud fleet with Pearl Harbor-like devastation.

Of course, in today's Navy, Nimitz wouldn't have survived beyond 0-5.

SKS and AK ACCESSORIES

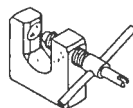

AK & SKS FRONT SIGHT TOOL all steel, adjusts windage and elevation (#G2033) \$29.95

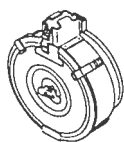

AK COMMANDO 75RD DRUM 7.62 x 39mm cal. These are the same drums used by assault teams world-wide. Also fits Valmet, Maddi, Hungarian, etc. (#G2000) \$109.95



SKS/AK STRIPPER CLIPS These are new, no rust! 10 per pack (#G2013) \$6.95

SKS DETACHABLE* 30 RD MAGS looks just like the AK mag. No modifications required for the weapon. (#G2092) \$29.95

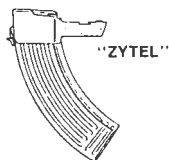

*Detachable SKS mags are sold only for replacement on SKS & using detachable mags prior to 11:30 sec 922/R1

Get yours before these are banned!

AK or SKS STOCK EXTENSION black rubber buttpad, extends the stock out an extra inch. Has hole for easy access to cleaning kit. AK Stock extension (#G2006) \$9.95 SKS Stock extension (#G2007) \$9.95



AK CHEST POUCH Holds six 30-round AK magazines, plus for small pouches for stripper clips, cleaning kit, etc. (#G1619) \$17.95

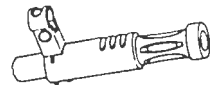
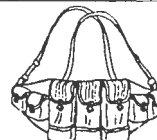

SKS MAXI BREAK provides excellent muzzle control, reduces flash and cuts recoil. (#G2055) \$34.95

AK RECOIL COMPENSATOR

Based on the original Kalishnikov design, but made in the USA (#G2005) \$29.95

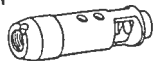

Exact copy of Russian Unit

BEST SELLER!

SKS & AK OWNERS MANUAL a must for every SKS, AKS, or AK-47 owner or user. (#GB-896) \$3.95

AK SPEED LOADER original Chinese (#G2001) \$8.95



SKS PISTOL GRIP makes your SKS look and feel like the AK47. (#G2019) \$23.50

WHILE SUPPLIES LAST!



SKS FOLDING STOCK fits both spike and blade bayonet models. (#G2064) \$79.95

AK and SKS FOLDING BI-POD all steel. Attaches quickly. (#G1790) \$46.95

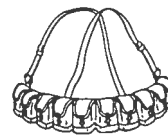

SKS BANDOLIER CHEST POUCH original Chinese, has 10 pockets, adjustable straps. Great for carrying ammo and stripper clips. (#G1631) \$14.95



AK VERTICAL FOREARM offers more control and less heat buildup. Works on all Norinco or Polytech AKS with folding or wood stocks. Sturdy one-piece construction. (#G2039) \$24.95

AK and SKS 5-PIECE COLORED FRONT SIGHT SET Gives you a better sight picture than ever before. Red, white, yellow, orange and black. (#G1305) \$4.95 set



ORDERS ONLY CALL 1-800-239-7435
205-222-1931 / FAX 205-222-2309

| SHIPPING CHART | ADD |
|-----------------|------|
| 0.00 - 35.00 | 4.95 |
| 35.01 - 60.00 | 5.95 |
| 60.01 - 100.00 | 6.95 |
| 100.01 - 150.00 | 7.95 |
| 150.01 or over | 8.95 |

*AK, HI, Canadian orders add \$4.00.

CALL TOLL FREE TO ORDER OR SEND CHECK OR MONEY ORDER TO CROWN SPECIALTY CO. DEPT. SF, P.O. BOX 488 • ANDALUSIA, AL 36420

COUNTERFEIT GUNS

that are inexpensive to own and safe to display in your home. They are realistic, full size working metal models that look, feel, weigh and handle like the expensive originals. You can work the action, release the clip and dry fire these high quality models.

CANNOT BE FIRED!

ISRAELI UZI SUBMACHINE GUN

Used by Israeli troops in the historic 6-Day War, the Entebbe Raid. Adopted 30 other nations as the most successful sub-machine gun on the market today.



Over 72 parts folding metal stock detachable 32-round magazine. Length 25" Wt. 9 lbs.

#01-705M.....\$310 PPD

Exact Replicas In Metal!.....

1921 THOMPSON

as used by FBI & U.S. combat troops. Over 59 parts, including vertical foregrip, detachable wood butt-stock & 20-rd. magazine. Lgth. 35". Wt. 9.5 lbs. Disassembles like original.



#01-700.....\$299 PPD

Full size (non-firing) models look, weigh, and handle like the originals.

M-16 ASSAULT RIFLE

The ultimate defense arm as used by S.W.A.T. forces. Made famous by U.S. troops in S.E. Asia. Full size. Bolt functions like original—over 70 ABS plastic and metal parts. CANNOT BE FIRED. Lgth. 39". Wt. 5 lbs.



Declared "non-gun" by the Federal Gov't. #39-2707.....\$300 PPD

FULLY ASSEMBLED

U.S. 45 AUTOMATIC

A favorite of GI's for 80 yrs., from WWI to Vietnam. This metal "non-firing" replica model is exact in every detail—even the grip safety works. Blued finish. Can be disassembled. L: 8.5" W: 2.5 lbs. #01-300

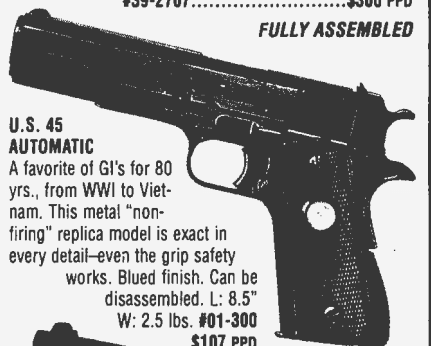

\$107 PPD

M92 AUTOMATIC

This massive 9mm was chosen to replace the .45 auto. Made famous in Operation Desert Storm, this blued "non-firing" metal model actionworks like the original. Can be partially disassembled. L: 8.5" W: 3 lbs. #22-1254.....\$102 PPD



COLLECTOR'S ARMOURY
800 SLATERS LANE, DEPT. SO
BOX 59, ALEXANDRIA, VA 22313

Not sold to Calif. except for theatrical use.

SEND: _____ SEND FREE CATALOG
Credit Card Orders: 1-800-544-3456 Ext. 515

NAME _____

ADDRESS _____

CITY/STATE/ZIP _____

MONEY BACK (LESS POSTAGE) IF NOT SATISFIED

He was too tough and too abrasive; back in the 1920s, he ran his ship aground on a sandbar. One strike in today's zero-defect military and you're out. Thank God it wasn't that way back then, or we'd all be speaking Japanese.

Three weeks before our Rangers were slaughtered in Somalia, I asked a Pentagon official if I could spend a couple of weeks there with the 3/75th Rangers. The Pentagon staffer said he'd check. A few days later he replied, "General Montgomery is very sensitive about his Rangers and doesn't want the press around them." After the debacle, I spoke to a Montgomery aide, Major Dave Stockwell, in Mogadishu. He whispered over the telephone, "The Rangers did not belong to Montgomery. They belong to the special operations people."

The Rangers belonged to Montgomery before the crap hit the fan, but afterward, there were new fall guys.

It's the old story of fast shuffling and damage control. With ticket-punchers, no one is responsible and no one is accountable. Stockwell, trying his best to get his boss out of a jam with a fast-curve Army spin, went on to say, "In a Somalia-type of combat situation, principles of war like surprise and unity of command don't necessarily apply." This is like a drunk driver saying to a police officer that red lights don't mean zilch after the fourth drink.

Stockwell did admit his boss "could have vetoed" Garrison's ill-fated raid.

Long dead, old-school paratroop Gen. Joe Cleland hit the problem right between the eyes when he said, "There are no bad units, just bad officers." An Army captain, Frank Staley (who recently quit the Army in disgust after 12 years' service) told me, "The old adage of defending what's right and correcting that which isn't has given way to toeing the line, defending the status quo and fitting in. No one stands tall anymore."

This sickness has spread throughout the ranks. The young, idealistic and eager — the best and the brightest — must emulate the slick moves of their fast-track superiors or get out. There is little room for total honesty in the system, and subtle cheating and erasing has become the sad standard. To clock the best time, an ambitious captain runs his company

HANDSTRAPS™



Strengthens your fingers, thumbs, hands, wrists, and forearms.

DEVELOP THE DEATHGRIP WITH THE BEST HAND STRENGTHENING METHOD IN THE WORLD!

FORGET THE OTHER STUFF. THEY DON'T WORK. YOU NEED THIS. THE HANDSTRAPS COURSE WILL TRIPLE YOUR GRIP STRENGTH IN 30 DAYS. IT'S EASY, NOW THAT THE BARBELL PRINCIPLE OF ADDING WEIGHT AS YOUR STRENGTH DEVELOPS HAS BEEN APPLIED TO THE HANDS. WANT THE STRONGEST GRIP IN THE WORD?

YES! AS A MAN OF ACTION, MY LIFE IS IN MY HANDS. Send your name, address, and 14.95 + 2.00 S/H to:

HANDSTRAPS COMPANY
DEPT. A, P.O. BOX 32547
CLEVELAND, OHIO 44132
Used by professional athletes worldwide
30 DAY MONEY BACK GUARANTEE

BELTBAG HOLSTER

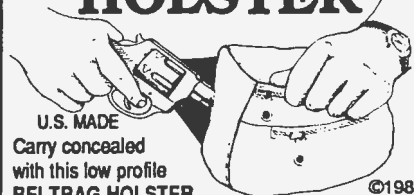

U.S. MADE
Carry concealed with this low profile **BELTBAG HOLSTER.** ©1989

You can carry MACE, STUN GUNS, or a PISTOL in the false back. Simply rip open the hook & loop and snap closure for quick access to the contents. The BELTBAG HOLSTER is made from black leather or 1000 Denier CORDURA Nylon in 4 sizes. The Nylon bag is available in solid blue or solid black, or two tone using one of 4 trim colors (grey, maroon, turquoise or blue). Left hand or long belt available on request at no extra charge.

- Style #1- fits small 22, 25 autos up to AMT back up
Nylon...\$15.00 Leather...\$35.00
 - Style #2- fits 2" S&W J-frame, Walther PPKS, Colt Gov't 380
Nylon...\$20.00 Leather...\$45.00
 - Style #3- fits Colt OM, Glock 19, S&W 6900, B91.3, 2" S&W K-frame
Nylon...\$25.00 Leather...\$55.00
 - Style #4- fits Colt 1911, Browning HP, Beretta 92, 3" Revolver, most large autos
Nylon...\$30.00 Leather...\$65.00
- (*\$3.00 S&H) Call or write for FREE catalog

KG Products
1740W Churchill Dr.  
Oakland, OR 97462
1-800-944-7717

downhill on the two-mile run. To make sure the training test goes right, the general stacks the deck and sends only the heavyweights, not the average team. A battalion CO at Fort Bliss even wanted his unit's evaluation test score to be higher, so he declared a "bad weather multiplier" increase of 10% — there was mud on the training field.

There will be more shoot-outs like Mogadishu down the bloody track. With war-fighters at the helm next time around, our soldiers won't be tossed away like used Kleenex, but looked after, treasured and placed on the field with everything they need to win. We cannot expect the current generation of ticket-punchers to fix things. They must be replaced with today's captains, majors and lieutenant colonels who are still close to their troops and haven't forgotten the difference between right and wrong.

David Hackworth is America's most-decorated living veteran who served 25 years in the U.S. Army. In 1989 he authored the international best-seller About Face. ✕

NEW FRONTIER

Continued from page 56

smaller backup we advised the Glock 19. For carry, we urged adoption of the various holsters available (guns stuck in trousers and pockets were the norm). If the threat level were to increase (as it now has), we suggested one submachine gun per vehicle, our choice being any variant of the H&K MP5 or carbine version of the AR-15/M16.

Our efforts went exceedingly well. If there was anything that interfered with our ability to make a greater impact, it was not the specific individuals with whom we worked, but rather the system within which they operated. In Mexico, we found that too many of the "troops" were excellent human material who were forced not just to work, but to struggle to survive (together with their families) under "leaders" who were neither professionally nor morally sound. The pressure to cut corners, therefore, was intense at every level, especially on middle management.

Living with the personal hang-ups

of inferior "superiors" can be trial enough. But mix this orientation with "superior" shortcomings in training and ethics, and a witches' brew was at hand. We could handle it, because we knew we could just walk away. The *peons* didn't often have that option.

The restive environment caused by the system includes many inequities that are chickens waiting to come home to roost, and we said as much. The training we had provided suddenly took on another light indeed with the Chiapas affair. The 1994 series of events corroborated our analysis, when even the highest levels of government and commerce were touched. It certainly cast the "threat situation" in a more serious light.

Even as we departed, our final words (delivered in writing) were clear: Your security training will stand you in good stead, regardless of circumstances. Yet an internal war scenario, especially one featuring determined efforts at assassination and bombings, requires an enhanced mode of operation we have not covered.

Mexico's great fear is that it may be entering just such a scenario, where an entire nation may have to adjust to

ONCE IN A LIFETIME OPPORTUNITY!

The **NEW IMPROVED** Poor Man's

BUY IT BEFORE IT'S BANNED!

Kurt James Bond



CONTENTS:

- 1. THE POOR MAN'S JAMES BOND
- 2. THE POOR MAN'S JAMES BOND
- 3. THE POOR MAN'S JAMES BOND
- 4. THE POOR MAN'S JAMES BOND
- 5. THE POOR MAN'S JAMES BOND
- 6. THE POOR MAN'S JAMES BOND
- 7. THE POOR MAN'S JAMES BOND
- 8. THE POOR MAN'S JAMES BOND
- 9. THE POOR MAN'S JAMES BOND
- 10. THE POOR MAN'S JAMES BOND
- 11. THE POOR MAN'S JAMES BOND
- 12. THE POOR MAN'S JAMES BOND
- 13. THE POOR MAN'S JAMES BOND
- 14. THE POOR MAN'S JAMES BOND
- 15. THE POOR MAN'S JAMES BOND
- 16. THE POOR MAN'S JAMES BOND
- 17. THE POOR MAN'S JAMES BOND
- 18. THE POOR MAN'S JAMES BOND
- 19. THE POOR MAN'S JAMES BOND
- 20. THE POOR MAN'S JAMES BOND

The New Improved

The Poor Man's **JAMES BOND**

Now you can own **THE POOR MAN'S JAMES BOND!** By special arrangement with the author, we have printed only 4000 copies! Just reviewed by the FOX network! The most infamous book ever written! NOW available for about 50% of what competitors offer it for! **Only \$12.00! Regular \$22.00!** For the public only, 477 pages of the most valuable information a patriot/anarchist could ever desire!

Not ~~\$22.00~~ ONLY \$12.00

24 Hour Order Line 318-688-1365 FAX 318-688-1367

N.I.C. INC. 500 Flournoy Lucas, PO Box 5950-JF
Shreveport, LA 71135-5950

Order Name _____
#B450 Address _____
\$12.00 plus City/State/Zip _____
\$3.00 per Card# _____ Exp _____
book P&H VISA MC M/O CHECK

SAME DAY SHIPMENT!

NIGHT VISION



MPN 95K Generation II Weapon Sight
3.5X Image Magnification • Automatic Brightness Control
Bright Source Protection • 60,000X Light Gain (Max.)
Uses standard 9 volt battery
\$1295.00

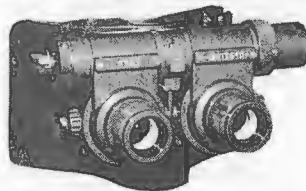

MPN 50K Starlight Goggles
40° Field of view • Detachable Infrared
Illuminator • 50,000X Light Gain (Max.)
Uses standard "C" battery **\$1695**

Moonwalker

Palm-sized viewer • 1 X Magnification.
6000 X Light Gain (Max.) •
Only 5" long • Detachable Infrared
Illuminator **\$495.00**



MPN 60K Generation II Plus Viewer
5.2X Image Magnification • Manual Brightness
control • Bright Source Protection • 60,000X
Light Gain (Max.) • Sharp, Hi-Contrast Image
Uses standard 9 volt battery.
\$895.



30 DAY MONEY BACK GUARANTEE ~ ONE YEAR WARRANTY

We carry the entire line of Russian Night Vision Systems, Goggles, Binoculars, Gyro Stabilized Binoculars and Weapon sights, call for information.

All of our Night Vision Systems are brand new, not reconditioned, with new Image Intensifiers for years of dependable service. All units include field cases, batteries and full instruction manuals. These units are made in Russia and are manufactured to Military specifications.

CALL TOLL FREE 1-800-841-3245

Or send check or money order plus \$9.00 S&H to:

Starlight Imaging Systems Inc.

17027 West Dixie Highway Suite 103

North Miami Beach, FL 33160

Phone: (305)949-0089

Fax: (305)949-0075



NOTICE TO CALIFORNIA RESIDENTS

Some firearms advertised in this magazine may or may not be lawful for sale in California. Those specifically not allowed for sale in California are:

A. All of the following rifles:

1. Avtomat Kalashnikovs (AK) series
2. UZI and Galil
3. Beretta AR-70 (SC-70)
4. CETME C3
5. Colt AR-15 series and CAR-15 series
6. Daewoo K-1, K-2, Max 1, and Max 2
7. Fabrique Nationale FN/FAL, FN/LAR AND FNC
8. FAMAS MAS223
9. Heckler & Koch HK-91, H-93, HK-94 and PSG-1
10. MAC 10 and MAC11
11. SKS with detachable magazine
12. SIG AMT, SIG 500 Series, and SIG PE-57
13. Springfield Armory BM59 and SAR-48
14. Sterling MK-6 and SAR
15. Valmet M62, M71S and M78
16. Amalite AR-180 Carbine
17. Bushmaster Assault Rifle (amgun)

19. Calico M-900 Assault Carbine

20. Mandall THE-TAC-1 Carbine
21. Plainfield Machine Company Carbine
22. PJK M-68 Carbine
23. Weaver Am Nighthawk

B. All of the following pistols:

1. UZI
2. Encom MP-9 and MP-45
3. MAC 10 and MAC 11
4. INTRATEC TEC-9
5. Mitchell Arms Spectre Auto
6. Sterling MK-7
7. Calico M-900

C. All of the following shotguns:

1. Franchi SPAS 12 and LAW 12
2. Gilbert Equipment Company Striker 12 and SWD Street Sweeper
3. Encom CM-55

SOLDIER OF FORTUNE MAGAZINE

this "enhanced mode of operation." Though good for business, it's not what we would wish upon our clients.

Dr. Tom Marks is SOF's Chief Foreign Correspondent. ✕

RANCH SECURITY

Continued from page 57

up by a cadre of *gatilleros* (cat men) who earn from \$300 to \$500 per month.

While the larger ranchers have security staffs, smaller ranchers stand ready to contribute manpower, relying on arms accumulated by the larger spreads. Armament on the smaller ranches is usually restricted to the light weapons authorized by the Mexican government. Legally, ranchers may carry .22 rifles and pistols, along with 16-gauge shotguns: firearms that the government considers useful against varmints and for procuring food — but lacking in terrorist potential. Unfortunately, these guns are of little use against well-armed insurgents, so the larger ranchers procure arms on the black market, where guns flow in from the south and the north.

Typical of the large shipments from the north was a three-ton truck seized in Veracruz five days after the New Year's Day attack. The truck, filled with Colt AR-15s, Galils, Valmets, Ruger Mini-14s and a few grenade launchers, was driven by an American who is now in the infamous federal prison known as "Pacho Viejo." On a smaller scale, there are "contraband ants" who carry small amounts of ammunition across the Texas border. A handbag full of ammo can net the contraband ant several-hundred dollars in profit. From the south, smuggled arms come into Chiapas by land and by sea.

Plenty of small arms were left over from the superpowers' involvement in Central America, and the southern border of Chiapas is only 300 miles up the isthmus from the embattled zones of Nicaragua and El Salvador. The east coast of Central America, with its sparsely populated jungles and thousands of ocean inlets, is a smuggler's paradise. The Rio Usumacinta, which originates in Guatemala's eastern jungles, forms the eastern border of Chiapas and is a convenient

"INCREDIBLE" Guns Magazine "ABSOLUTELY AMAZING" Guns & Ammo "BEST LEGAL FULL AUTO" Soldier of Fortune

UNLEASH "HELL-FIRE"

Do you own any Semi-Automatic and want to Rock 'N Roll! Well, the all-new "HELL-FIRE" Trigger System is here! You won't find anything closer to a "Select Fire" Conversion, and it's LEGAL! The unit is installed externally in seconds. It does not interfere with the normal operation of trigger. When engaged, you may fire bursts, to emptying complete magazines at a full automatic rate accurately and legally! Hurry and get yours now before it's too late! Minimum age to order - 18 years.

MODEL HFS (UNIVERSAL) FOR MOST SEMI-AUTOMATICS **\$2995 COMPLETE PREPAID**

MODEL HFS 22 FOR 10/22 **\$1995 COMPLETE PREPAID**

PHONE ORDERS ONLY (303) 249-2694

OR SEND CASHIER'S CHECK OR MONEY ORDER TO:

(PERSONAL CHECKS DELAY ORDER)

HELL-FIRE SYSTEMS INC. Colorado residents add 4% Visa/MC

P.O. BOX 549, OLATHE, CO 81425

U.S. Pat. & Other Patents Pend.

10/22 • TEC 9 • 22 • SP 89 • MI GARAND • MAC 11/9 • AP9

AR15 • MINI 14,30 • M1A • 30 CARBINE • AKS • DAEWOO • FNC • HK 91, 93, 94 • AT 9 • CAMP 9, 45 • SKS • FAL

THE BEST! Improved Survival Odds LIFETIME WARRANTY

conduit for north-bound weapons.

At prevailing prices for automatic weapons in Mexico, the profit on a boat-load of guns can make a peasant rich by local standards. An AK-47, known as a "Ram's Horn" because of its curved magazine, is the market-maker for automatic weapons and regularly sells for U.S. \$1,000. Semiauto weapons also sell at roughly double their stateside prices.

As the threat to their livestock, crops, equipment and key personnel increases, larger ranches tend to increase their use of security professionals rather than simply detailing more ranch hands as shotgun-toting guards and door-shakers. Job opportunities in ranch security, however, are best for gringos who are thoroughly fluent in Spanish and the Mexican culture, and who have a professional background in supervising rural security operations. There is plenty of indigent labor available — cheap — and gringos need to have specialized (and locally unavailable) skills if they hope to find employment in ranch security.

At this writing, it appears likely that urban Chiapas will be occupied by federal troops for months, if not years to come, but rural areas will continue as a no man's land. It is possible that the high mountain jungles will come to be regions ruled by tribal rather than administrative law. Adventurers can then add southern Mexico to their list of places to keep an eye on, along with the Khyber Pass, the Golden Triangle and other areas where guns rule. As for the ranchers of Chiapas, they will get by, perhaps with a little help from their friends.

Douglass G. Norvell has a doctorate in Agricultural Economics from Texas A & M and teaches in the College of Business at Western Illinois University.

BRANCH DAVIDIANS

Continued from page 49

"It is going to be a very exciting time. I understand the difficulty the jury [went] through to make a decision," Fagan said. "The prosecution certainly did not prove its case ... There

Continued on page 76

★ LEGISLATIVE ALERT ★

Handgun Control Inc. is having so much success in banning guns, now they want to BAN BOOKS.

The following is an excerpt from an 11 page document that is being distributed via the Internet (A computer network used mainly by government, universities and the military.) According to the person that originally uploaded the file, it was leaked by an insider at Handgun Control, Inc. and all pages were marked CONFIDENTIAL.

"Control of Dangerous Literature (Bomb making, machine gun conversions, etc...). Too much irresponsible material is purportedly covered by the 1st Amendment, however, the time will come when our nation has to agree that some literature does not belong in a safe society, like instruction manuals on how to kill, or how to make homemade explosives, or nuclear bombs. We must realize that there can be such a thing as too much freedom where such literature poses a serious threat to the public safety."

To receive a copy of the complete document that outlines Handgun Control Inc.'s plans for the future, including the elimination of YOUR guns send \$3.00 (check or money order) to:
Handgun Control Report • P.O. Box 4 • El Dorado, AR 71731

The Top Books They Don't Want You To Have*

If They Say They're So Bad, Shouldn't You Own Them?

The HCI document does not list any particular book titles. But, what other books could they mean?

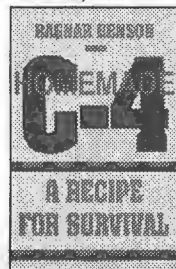
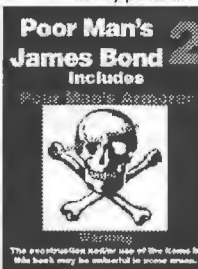

- C-065 Poor Man's James Bond Vol. 1 \$21.95
The Most Dangerous "How-To" Manual in America
8 1/2"x11", over 400 pages, illustrated, soft cover.
- C-372 Poor Man's James Bond Vol. 2 \$21.95
More utterly outrageous "How-To" information.
8 1/2"x11", 480 pages, illustrated, soft cover.
- The Improvised Munitions Black Books**
Produced for CIA & Special Forces use.
- C-150 Black Book Vol. 1 \$12.95
5 1/2"x8 1/2", 145 pages, illustrated, soft cover.
- C-151 Black Book Vol. 2 \$12.95
5 1/2"x8 1/2", 137 pages, illustrated, soft cover.
- C-152 Black Book Vol. 3 \$21.95
8 1/2"x11", 162 pages, illustrated, soft cover.

- C-689 Homemade C-4 \$14.00
Step by step instructions that require no special tools.
5 1/2"x8 1/2", over 44 pages, illustrated, soft cover.
- C-066 The Anarchist Cookbook \$24.95
The most notorious "How-To" manual on the market.
8 1/2"x11", 160 pages, illustrated, soft cover.
- C-9052 The Private Weaponeer \$9.95
The guide to making tracers & other little bombs.
5 1/2"x8 1/2", 49 pages, illustrated, soft cover.
- C-9084 Assorted Nasties \$19.95
The handbook of poisons & application devices.
5 1/2"x8 1/2", 138 pages, illustrated, soft cover.
- C-113 Submachine Gun Designers HB \$14.95
A handbook on the design & construction of SMGs.
8 1/2"x11", 94 pages, illustrated, soft cover.

Sorry, We don't have the book on how to build a Nuclear Bomb, but we're still looking!

Credit Card Orders Only call our
Toll-Free Order Line
1-800-852-4445

Customer Service
1-501-862-4984

Fax Number 1-501-862-9671

Allow 2 weeks for delivery



Sorry No C.O.D.'s

Add \$4.95 S&H to all orders plus an additional \$3.00 for orders to Canada. Other foreign add \$12.00 for first item & \$2.00 for each additional item.

Send Check or Money Order to:

DELTA PRESS
P.O. Box 1625 Dept.-SF57
El Dorado, AR. 71731

Send \$3 for a 80 page color catalog (Free with order)

It's time to call in the heavy hitters!

Forget those "magic" bullets that turn into pretty stars or grow claws. Cor-Bon® offers street-proven performance, harder-hitting, higher velocities, and low muzzle flash that won't make you the target... all in the heavier bullet weights that the pros prefer: 230 gr. .45, 180 gr. .40, 158 gr. .38, 147 gr. .9mm and more. Cor-Bon ammo isn't fancy. It just plain gets the job done!

TO ORDER: **1 800 788-2666**



Become a gun repair expert!

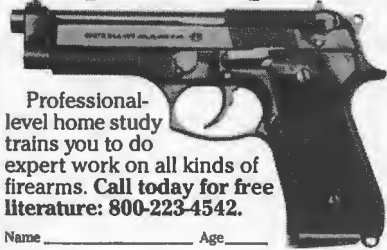

Professional-level home study trains you to do expert work on all kinds of firearms. Call today for free literature: 800-223-4542.

Name _____ Age _____
 Address _____ Phone (____) _____
 City _____ State _____ Zip _____

School of Gunsmithing, Dept GH171
 6065 Roswell Rd., Atlanta, Georgia 30328

SOUTHEAST ASIA HIKING CLUB

Black Logo on Gray T-Shirt placed on the pocket area

- 100% Made In USA
- 50% Cotton/50% Polyester
- Sizes M-XL •
- For XXL Add \$2.00 •



Send Check or Money Order for \$15.00 to:
 (INCLUDES SHIPPING & HANDLING)

SADDLE-UP-T'S
 P.O. BOX 891 - DEPT. SF74
 QUINCY, IL 62306
 For Complete Catalog Send \$2.00

Don't get fooled by Frauds 100% GUARANTEED Anabolic Muscle Building STEROIDS Replacement

This product is to be taken orally.
 No harmful side effects.
S&K Performance Product Boron!
 Can dramatically increase your **Testosterone levels up to 300%!**
 Higher Testosterone means faster, easier muscle growth! Greatly enhance your physical appearance literally sculpting your own body with huge healthy, hard muscle.

Get that lean awesome body builder physique now with one 3 month cycle for only **\$15.95!**
 If you are not completely satisfied with the growth you obtain within 15 days return it for a full refund.

Money back guarantee! To get your super anabolic growth cycle from:
 S&K Performance Products

Order Now!!!
 **\$15.95+shipping** 
1-800-398-6946
 24hrs. 7 days a week
 C.O.D.'s welcome add \$4.00 shipping.
 Check or money order send with
 \$15.95+shipping and handling to:
 S & K Labs, 2637 E. Atlantic Blvd. Suite 101,
 Pompano Beach, FL 33062

FREE!

Discount Knife Catalog

- Save up to 50% or more
- Huge selection
- Top quality--no seconds
- Fast service
- Satisfaction guaranteed!

Cutlery Shoppe

5461 Kendall Street Dept. SF
 Boise, Idaho 83706-1248
 Phone: 1-208-376-0430
 Fax: 1-208-376-7608

HK SPARE PARTS



CATALOG \$2.00
DELTA ARMS Ltd.
 Box 1100-F Delta, Utah 84624
 (801)864-3232 FAX 864-3331

When calling 911 just won't do...



TIMBERSHEPHERD®

-"The Mercedes Benz of executive protection dogs."
 -"The Premium K-9."
 -SOF Magazine
 Pups and Trained Adults Available
L R R P K-9 SERVICES
 Box 1620-MA
 Aiken, SC 29802
 (803) 649-5936
 Send \$3.00 U.S. funds for brochure.

PHOTO CARD KITS

MONEY BACK GUARANTEE!

Our Professional quality, laminated photo cards will amaze your associates! We provide the cards, plastic laminate and easy instructions! You provide only a photo. Your photo Card can be finished in the privacy of your home! The result is a distinctive, professional system! The highest quality cards in the US! Lost your original card? Replace it now!

only \$4.95 C203 Bail Enforcement Agent
 Select From These Kits:

| | |
|---|---|
| C04 <input type="checkbox"/> Bounty Hunter | C06 <input type="checkbox"/> Mercenary |
| C13 <input type="checkbox"/> Special Investigator | C41 <input type="checkbox"/> Intelligence Officer |
| C45 <input type="checkbox"/> MAC-V (CIA), #1 | C212 <input type="checkbox"/> Official Press |
| C60 <input type="checkbox"/> MAC-V(CIA), #2 | C46 <input type="checkbox"/> Special Forces |
| C14 <input type="checkbox"/> OCB | C47 <input type="checkbox"/> Seal Team |
| C52 <input type="checkbox"/> Air America Pilot | C18 <input type="checkbox"/> Pilot |
| C01 <input type="checkbox"/> Press Card | C03 <input type="checkbox"/> Security |
| C50 <input type="checkbox"/> Phoenix Program | C17 <input type="checkbox"/> Int'l Drivers Permit |
| C49 <input type="checkbox"/> Delta Force | C11 <input type="checkbox"/> Private Investigator |
| C25 <input type="checkbox"/> Parachutist, Certified | C02 <input type="checkbox"/> Bodyguard |
| C26 <input type="checkbox"/> SCUBA, Certified | C12 <input type="checkbox"/> Security Consultant |
| C07 <input type="checkbox"/> Weapons Specialist | C51 <input type="checkbox"/> Special Operations |

Any Three Only **\$11.95** Any Six Only **\$19.95**

NIC Law Enforcement Supply
 500 Flourney Lucas Rd. Box 5950-SV
 Shreveport, LA 71135-5950
COLOR CATALOG \$2.00 OR FREE WITH ORDER

Name _____
 Address _____
 City/State/ZIP _____
 Card # _____ Exp. Date _____
 VISA M/C CHK MO 24-hour order No. (318) 688-1365
 FAX # (318) 688-1387

After 'Nam: A Police Story



Howard Dale thought his warring days were over when he left Viet Nam. Then he became a cop...

Rich in detail and human passion, this is a frank and "street level" story of how one Marine Vietnam vet's war did not stop when he came home; Howard Dale merely changed uniforms from Marine to police officer.

"A book of artistry and great significance. A powerful novel that is long overdue."
 — Chuck Dean, author of Nam Vet: Making Peace With Your Past

Send only \$7.95 — full price— including postage, etc., payable to:

Carl Ax
 P.O. Box 25
 Earlville, PA 19519



Target to Adventure!

U.S. Cavalry has everything you'll need for your adventurous lifestyle! Over 100 full-color pages loaded with shooting accessories, knives, hi-tech optics, camping and survival gear, GPS's, official and tactical uniforms, communication equipment, flashlights, boots, military memorabilia, personal protection devices, target practice aids and much more. **Guaranteed 100% satisfaction!** For your catalog, send your name, address and \$3.00 to:



Dept. SF 2855 Centennial Ave.
Radcliff, KY 40160-9000

LEGIONNAIRES SURVIVAL BOOT KNIFE

ONLY \$12.98
Add \$1.05 Hndt.

Overall 9" Model K-99-A

Double edge 440 stainless steel blade. Full tang one piece construction. Leather sheath with quick release snap and metal boot/belt clip. **Money Back Guaranteed If Not Fully Satisfied!!**

WESTBURY SALES CO. DEPT BK-07-SF
156 Post Avenue, Westbury, New York 11590

A SIMPLE REACTION TO AFFIRMATIVE ACTION

Show support for your heritage!
Black T-shirt - high-quality design in full color
S - XL \$15 / XXL \$17 / U.S. add \$3 S&H
Foreign add \$6 S&H / Ca. res add 8 1/4% tax
Catalog available / Send ck or money order to:
P I G (Politically Incorrect Graphics)
P.O. Box 2147, Orinda, CA 94563
Ph: 510-531-5028 / Dealer Inquiries welcome

GENUINE BRITISH MILITARY KIT

- BRITISH DPM SAS SMOCKS
- BRITISH DPM PARA SMOCKS
- BRITISH DPM JACKETS ('68 PAT)
- BRITISH DPM TROPICAL SUITS
- BRITISH WOOLEY PULLY'S
- BRITISH DENISON SMOCKS
- BRITISH WEBBING PLCE, '58, '37
- BRITISH DPM DESERT SUITS
- BRITISH RUCKSACKS
- BRITISH DRESS UNIFORMS
- BRITISH POLICE KIT
- BRITISH PARA/SAS BERETS/BADGES
- BRITISH G10 ARMY WATCHES
- BRITISH W.W. II KIT

Orders dispatched by air mail £17.99 per order Visa/MC accepted.

Send for FREE catalogue to: Silverman's (SOF), Mile End, London E1 4PS. England
Phone 011-44-71-790-5257
Credit card orders 0717-900-900
Fax 011-44-71-791-0008

NAME _____
ADDRESS _____
CITY _____
STATE/ZIP _____

"The right of the people to keep and bear arms shall not be infringed."

Do it for your country...**BURY A:** *-The Bill of Rights*

Patriot Safe™
"Underground Burial System"
SALE!! \$65.00
Reg. \$ 89.95

58" LENGTH
8" Diameter

- * Air and water tight
- * Tactical black
- * Heavy PVC construction with quality materials.
- * Includes desiccant for added moisture protection
- * Complete instructions Do it NOW!!
- * MADE in the USA

We Accept MC, VISA, COD's or M.O's
Add 12.00 for S&H 18.00 for AK or HI

OUTBACK MERCANTILE
PO BOX 33614
NORTHGLENN, CO 80233
TEL(303)279-2571 FAX(303)278-7098

THE BODY SCULPTOR

Develop the body you've always dreamed of having. Add inches to your chest, arms, and thighs. Sculpt your stomach, buttocks, and calves. The Body Sculptor builds & tones muscles, and relieves stress and tension. Adjustable electrical impulses work your muscles more effectively than regular exercise. It's medically proven, effortless and safe! Use it at home, in the office, traveling, even while reading or watching T.V. **Results guaranteed in 30 days or your money back!**

Your unit includes the following: • 24 hr. customer service • Free AC wall adapter • Complete instructions • 5 year Iron-Clad warranty • Free Carry Case • 30 day trial period

A. BM-1004, 6-pad model w/AC adapter, \$220
B. BM-1006, 8-pad model w/ AC adapter, \$259
C. BM-1008, 12-pad model w/AC adapter, \$359
D. BM-1012, 16-pad model w/AC adapter, \$459
E. BM-1014, 18-pad model w/ AC adapter, \$499

• Add \$10 for ship. & handling • CA res. add 7.75% tax • Call Now For Immediate Delivery!
1-800-401-4677 (U.S. & Canada)
or send check money order to: David Steele
64 Lehigh Aisle, Dept. SOF 694, Irvine CA 92715

These Are The Finest Electronic Muscle Stimulators Available Anywhere!

HANDS-FREE NIGHT VISION

EXCLUSIVELY from HiTEK International, these proprietary goggles are manufactured at our own factory and are full of features not available even on much more expensive units. Now offered to you **factory-direct.** Great for use on boats, off-road vehicles or wherever you need both hands free while seeing in the dark!

We offer a full line of low-cost, high-performance Night Vision binoculars, goggles, spotting & rifle scopes.

NEW UNITS \$495! Plus \$12.95 S&H
FROM ONLY

30-Day Money-Back Guarantee!

Call Now: 1-800-54-NIGHT
VISA - MC - AMEX - DISCOVER
Californians add 7.75% sales tax

HiTEK
490 El Camino Real, Redwood City, CA 94063
TEL: 415-363-1404 • FAX: 415-363-1408
Use of these products for hunting & other activities may not be legal in your area

THE HOUND DOG

Sniffs Out Hidden Transmitters

Throughout the world today, corporations, professional men, and businessmen are spending millions annually to insure privacy in their offices and homes where important plans and policy making decisions are discussed and formulated. The "HOUND DOG" is a wise investment for anyone who has reason to believe that an eavesdropping device is now hidden, or may be hidden in the future, in either home or office. No radio transmitter, no matter how well it may have been hidden, can escape detection by the "HOUND DOG".

The "HOUND DOG" is an advanced electronic instrument designed for the sole purpose of locating hidden transmitters. An average size office or room can be thoroughly searched in only a matter of minutes. The "HOUND DOG" sniffs out any transmitters hidden in pictures, walls, desks, chairs, etc., regardless of their operating frequency.

The "HOUND DOG" is simple to use. Single knob adjustment calibrates the meter and any transmitter signal received is indicated by the meter movement. By simply sweeping the probe past walls, chairs, pictures, desks, etc. the presence of any transmitter will cause a rise in the meter reading. The meter reading will continue to rise as the probe approaches the transmitter.

We believe you will find the "HOUND DOG" outperforms most other units selling for several times the price. This item has been built since 1962. Each one is backed by a 3-year warranty by us.

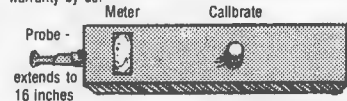

SIZE: 1.6 x 2.4 x 8.2 INCHES

\$195.00

USES A COMMON RADIO BATTERY



Super Powerful FM TRANSMITTER

Many times more powerful than other transmitters. Transmits up to 1/2 mile to any FM radio — Easy to Assemble Kit — up to 9V battery (not incl.)

\$19.95

Call 407-725-1000 or send \$195.00 plus \$5.00 shipping for Hound Dog and \$19.95 and \$1.00 shipping for FM Transmitter to USI Corp. P.O. Box SF-2052, Melbourne, FL 32902. COD's OK. For a catalog of transmitters, voice scramblers & other specialty items enclose \$2.00 to USI Corp.

NOW YOU CAN OWN THE ULTIMATE COMBAT/SURVIVAL KNIFE



GIANT 15 1/4" OVERALL

10" 420 J2 stainless steel blade. Holds complete survival kit. Hurry! While Supplies Last!

Money-Back Guarantee!

Super Low Price at **\$39.95** S&H

1-800-385-4103

OR RUSH CHECK OR MONEY ORDER FOR \$44.95 TO: HURRICANE INTERNATIONAL PO Box 109, Cold Spring Harbor, New York 11724

AK SPARE PARTS

AND OTHER NEAT STUFF!



CATALOG \$2.00

Global Sales P.O. Bx 1000-F Delta, UT 84624 (801)864-4402

See our collection on color VIDEO



SUB IRON CROSS WOUND
Your choice any one—\$10.00 or all 3—\$25.00. All are full size, not miniatures. These made from originals. Your choice WWI or WWII (state choice). We have most complete stock of WWI German badges-caps, etc. in U.S.



WWII U.S. CAP
U.S. Officer's Cap (new from original U.S. maker). Tan with brown leather visor, chin strap and U.S. Eagle pin. State size S, M or L, \$68.00. Have few Olive Drab, Wool \$74.00



GENERAL'S CAP
State S, M or L Size—\$88.00. Shoulder Boards, Set—\$31.00. Collar Tabs, Set—\$18.00. Complete, Knights Cross—\$21.00. The Complete Set. IN STOCK. ALL 4—\$137.00



AFRIKA-KORP. CAP & GOGGLES
German 1942 Mfg. ORIGINAL sand & dust goggles. Still in their pocket pouch. Tan Otc. caps—New REPLICA. State S, M or L size. Both Only \$39.00

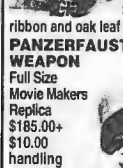

U-BOAT CAPTAIN'S CAP
White top Gold insignia and visor braid. Leather chin strap. State size wanted \$110.00 Knights Cross with ribbon and oak leaf with swords \$21.00

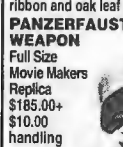

PANZERFAUST ANTI-TANK WEAPON
Full Size Movie Makers Replica \$185.00+ \$10.00 handling



For the back of your jacket... Flying Tigers BloodChit Patch 7" X 11" good reproduction—\$25.00 (your choice of American or Chinese flag). VIDEO — our collection w/prices...on VHS VIDEO only \$20.00 postpaid. (Free w/any \$25.00 + order.

W.W.#2 Ltd. Box 2063-F St. Louis, Mo. 63158

PRIVACY ?

Avoid BIG BROTHER. Best techniques for creating COMPLETE PRIVACY!

- Avoid Surveillance, Eavesdropping
- Become "Invisible" to Investigators
- Stop Generating Financial Records
- Communications Privacy . . Phone, Mail
- How to Stay Out of Government Files
- Begin Eliminating Negative Records
- How to Create Helpful New Records
- Generating Quick Cash Income
- Hiding Your Assets ■ Privacy Afloat
- Banking Alternatives ■ "Low Profile"
- Privacy from Taxes ■ Nomadic Living
- Multiple Addresses
- Hideouts, Deep Cover
- How to "Disappear"

ALL THE PRIVACY YOU WANT — and MORE!
Visa/MC: 800-338-8484

ONLY \$18.95



EDEN PRESS
11623 Slater "C", Box 8410-AP Fountain Valley, CA 92728

Your Choice Regular P&H, \$3.00 (Please add FIRST CLASS, \$6.00 to order.)
(California residents please add 7.75% sales tax.)
 Send latest Book Catalog — FREE.

Name _____
Address _____
City _____
State _____ Zip _____

Factory New, Military

NIGHT VISION

Binoculars, Scopes & Goggles From Only \$399.00!

Previously unavailable to the civilian market. Now you can own starlight technology originally developed for the Russian Military and KGB. Great for camping, boating, photography, nocturnal wildlife observation, survival, security, surveillance - or just plain fun!

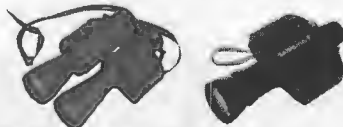

Baigish™-BN-453 Starlight 3.2 Magnification Only \$545.00!
Baigish™-1AF Starlight Camera Adaptable Only \$795.00!

Plus \$12.00 S&H. Californians add 7.75%

ONE-YEAR WARRANTY 30-DAY UNCONDITIONAL 100% MONEY-BACK GUARANTEE!



CALL NOW: 1-800-424-8222

M•O•R•O•V•I•S•I•O•N
219 Broadway, Suite 307 Laguna Beach, CA 92651
Tel: 714/497-4683 • Fax: 714/497-1270

FREE CATALOG

CAPITALIZE ON CRIME

IT CAN PAY HUGE PROFITS!

EARN HUNDREDS DAILY!

CRIME PREVENTION IS A MULTI-MILLION DOLLAR BUSINESS!!

OUR DEVICES SELL LIKE CRAZY!

WE SELL SECURITY PRODUCTS WORLDWIDE.



WE CARRY THE BEST LINE OF SECURITY SPRAYS, STUN GUNS, PERSONAL SOUND ALARMS, BURGLAR ALARMS AND MUCH MORE. WE SPECIALIZE IN OFFERING THE BEST SECURITY PRODUCTS AT THE VERY BEST WHOLESALE PRICES. \$3.00 S&H.

KEY CHAIN SPRAYER RETAILS: \$19.95 SAMPLE: \$9.95
POCKET PEN SPRAYER RETAILS: \$14.95 SAMPLE: \$6.95
PERSONAL SOUND ALARM 130 DECIBELS RETAILS: \$39.95 SAMPLE: \$14.95

ELECTRONIC STUN GUNS RETAILS \$69.95 SAMPLE: \$29.95
INFRASONIC BURGLAR ALARMS RETAILS \$429.00 SAMPLE: \$249.00

CALL OR WRITE TODAY!
WE ARE COMMITTED TO YOUR SUCCESS. CRIME DOES NOT WAIT! I WILL YOU?
L.A. LAW ENFORCERS
1005 No 1st St., Dept. SOF
Yakima, WA 98901
(509) 457-9033 FAX (509) 575-1875

GUN PARTS CORPORATION

SUCCESSORS TO NUMRICH ARMS
THE WORLD'S LARGEST GUN PARTS SUPPLIERS
 PRESENTS ITS NEW #18 CATALOG

Featuring an inventory of over 450 million gun parts we have for sale. A 650+ page catalog with exploded drawings that are invaluable to the gunsmith or hobbyist. Commercial, military, antique and foreign gun parts (many exclusively available from us) are listed and priced along with accessories, surplus & specialty items. A veritable encyclopedia of gun parts, this catalog will pay for itself time and time again with information and time saved in identifying parts.

U.S. \$5.95 SURFACE FOREIGN \$10.95
 send AIRMAIL WRITE FOR QUOTE
 GUN PARTS CORP. BOX SF0794, W HURLEY, NY 12491
 914-679-2417 FAX 914-679-5849

MMC UNIVERSAL FN FAL/LAR SCOPE MOUNT

Fits all models including Paratrooper.



59.95
 Plus \$4.00 Ship/Hand
 TX Res. Add \$4.65 Tax

MMC UNIVERSAL AK SCOPE MOUNT

Fits all AK (KALASHNIKOV) type firearms.



39.95
 Plus \$4.00 Ship/Hand
 TX Res. Add \$3.10 Tax

Both mounts are lightweight, ultra low profile & rigid. Unobstructed view of iron sights over mount. Field stripping capabilities retained with scope and mount in place.

MMC MINIATURE MACHINE CORP.
 606 Grace Ave. / Dept. 50F
 Ft. Worth, TX 76111 / (817) 831-0837

STEROIDS

D-BALL TEST DECA JET

Anabolic Steroids increase Testosterone levels to Build Muscle Mass and Strength

Now there is a safe and effective replacement for steroids. **Boron***. Tens of thousands have used **Boron** from JTR Labs to successfully replace steroids without the harmful side effects. *Guaranteed*. Check out these results. All from **Boron** users.

"...200 pounds of muscle in three months..." Willie Beck III. AL
 Terry Goetz. VT. Put 90 pounds on his bench. "...two inches in my chest..." J. Ramsey. TX
 "...its the extra edge I needed..." Charles Walters, Military
All these amazing gains using Boron.

For your own Huge Increases - Order your 3 month cycle of **Boron** today. Only \$19.95, shipping included. Blow away your competition and order now.

*Boron is a safe, 100% natural nutrient

COD's, Credit Card, Catalog orders call:
1-800-962-4769....ask for dept.#622
 Order lines open 24 hours 7 days a week
 Send check or money order to:

JTR LABS
 19230 Bach Blvd.
 Dept.#622
 St. Louis, MO 63132

MasterCard VISA

HOME OF THE LIFETIME GUARANTEE

WARNING: Accept no imitations or copy cats. JTR Labs, gives you the highest quality **Boron**. For 6 years. Unlimited Guarantee.



BULLETPROOF VEST

Will stop the .357 Magnum, 9mm and 00 Buck. Meets and exceeds "Threat Level II-A" tested in accordance with the NILECJ-STD-0101.01. Weighs 2 3/4 lbs. Fits easily under T-shirt.



Front & Back Protector \$220
 Detachable Side Panels \$45
 Chest Trauma Plate \$35

Officially tested by the U.S. Government Edgewood Arsenal at the Aberdeen Proving Grounds under the U.S. Department of Justice Standards. State height, chest and waist measurements.

MATTHEWS POLICE SUPPLY CO.
 (a division of David Matthews, Inc.)
 P.O. Box 1754 Dept. SF
 Matthews, N.C. 28105
 Ph. (704) 847-8793 FAX: (704) 847-4447

Automatic Knives

Only \$29.95 each!

Cutting Edge Enterprises presents the legendary *Nato Military*. Protection at the touch of a button! Lightning fast, stainless steel blade and shock resistant handle. Orders for 3 or more knives receive a free push knife valued at over \$15.00 24 hr. order turnaround and best price guaranteed (slight delay on personal checks). Don't delay, order now! C.O.D. orders call toll-free anytime. Send check or M.O. + \$5 shipping to:



Cutting Edge Ent.
 2101 W. Broadway #171
 Columbia, MO 65205-6018
1-800-554-5880

- 1 for \$29.95
- 2 for \$49.95
- 3 for \$69.99
- 4 for \$84.99
- 5 for \$99.99

Dealers welcome- MO res. add 6.975% tax

Name _____
 Address _____
 City _____ St _____ Zip _____
 Quantity: _____ Total \$ enclosed: _____

30 DAY MONEY BACK GUARANTEE

Be a DETECTIVE

SPECIAL SOF PRICES! AND EARN YOUR BADGE
NO EXPERIENCE NEEDED

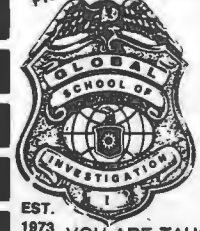

MEN - WOMEN
 TRAIN AT HOME FOR AN EXCITING PART OR FULL-TIME CAREER AS A PRIVATE DETECTIVE. START YOUR OWN AGENCY OR WORK FOR OTHERS. LEARN ALL THE LATEST TECHNIQUES FROM THE EXPERTS.

EST. 1973

YOU ARE TAUGHT BY FORMER MILITARY INTELLIGENCE SPECIALISTS, POLICE AND PRIVATE DETECTIVES. "THE ONLY COURSE OF ITS KIND." YOUR PAST EXPERIENCE COMBINED WITH THE UNIQUE GLOBAL PROGRAM

WILL MAKE YOU A PRIVATE DETECTIVE.



"Now earning \$100,000 a year as a P.I. Thank you Global."
 A.R. Texas

CALL NOW 617-721-4292

NO OBLIGATION • NO SALESMAN

GLOBAL SCHOOL OF INVESTIGATION
 171 S. PARK ST. STONEHAM, MA 02180

NAME _____
 ADDRESS _____
 CITY _____ STATE _____ ZIP _____

FREE INFORMATION

BODY ARMOR THAT STOPS .44 MAGNUMS and weighs only 3-lbs!



SOFT, COMFORTABLE, CONCEALABLE BODY ARMOR MADE WITH 18 LAYERS OF DUPONT KEVLAR (U.S. ARMORS IIA VEST HAS 14 LAYERS, ARMO-TECH HAS 15 LAYERS)

MED: \$149.99 LRG: \$189.99 XLRG: \$259.99
Adjustable ballistic panel carriers available in white, navy, OD and brown.

5-YEAR WARRANTY ON BALLISTICS

Prepaid orders include shipping. \$10 charge for CODs. One week shipping for stock sizes. State height and weight when ordering. Money orders and certified checks accepted. CODs cash only.

MICHIGAN BODY ARMOR
P.O. BOX 243 LATHRUP VILLAGE, MI 48076 313-788-2234

Exhibitors

15th ANNUAL SOF EXPO SANDS CONVENTION CENTER LAS VEGAS, NEVADA

Show dates & hours

Sept. 16, 1994 1000 — 2000 hrs

Sept. 17, 1994 0900 — 1800 hrs

Sept. 18, 1994 0900 — 1600 hrs

Our 1994 SOF EXPO will be held at the Sands Convention Center, Las Vegas, Nevada. Products displayed and available for purchase include military equipment, weapons, ammo, gun parts, holsters, misc products, optics/scopes/mounts, police equipment, re-loading, security, surplus, training and many more!!

Reserve your space now: Exhibitors are reserving space and we are 60% booked. Don't miss this exciting opportunity to sell your merchandise to an entirely new group of potential buyers. For info on the 1994 SOF EXPO call: (303) 449-3750 Fax: (303) 444-5617, or write to

SOF '94 Convention,
P.O. Box 693, Boulder, CO 80306.

Continued from page 71

was no conspiracy ... What [the jury decided] was a compromise, something to soothe the political situation. I feel it was an injustice. We were innocent, period. We defended ourselves.

"I think what the ATF did was totally and absolutely unjustifiable," he said, denying testimony he participated in the gunfight and shot two ATF agents.

Faith Not Destroyed By Fire

The death of David Koresh will not mean the end of the Branch Davidian religion, Fagan said. "He was merely a mouthpiece for [the spirit] that was leading us. That which was leading us is *in* us. It is not a case of our being led as a group. We are individuals, people like you. Every so often, we have a Coke. We like ice cream. We take our kids for a walk. But everyone is led by a spirit that is within them.

"If you read the Scriptures, it is not about external government. The whole process of God is that you have individuals who govern themselves. If you live in righteousness with God, you don't need an external power. But when you lose that internal reality of self-control, then that void is replaced by an external government, which is what you are seeing right now in the U.S."

Fagan, a former theology professor and ordained minister in England, said he doubts the former Mount Carmel residents will try to regroup.

"We don't need to," he said. "We have been subjected to just about everything the government can throw at us. And all you media people, what did you do to us during the period between February 28 and April 19? We were dehumanized and demonized. We were a cult! We were portrayed as criminals. We were subjected to all of that and guess what? I still have my faith. What have you got? ... You all come here and say you are seeking to understand us. Do you understand yourselves? If somebody comes into your house, where your wife and your children are, and threatens you, what are *you* going to do? Roll over and die?"

James L. Pate covered the Mount Carmel standoff and subsequent inferno for SOF last year, and was present for the entire trial this year. ✕

ADVERTISERS INDEX

| | |
|--------------------------------------|---------|
| Amazing Concepts | 15 |
| Automatic Knife Resource Guide | 62 |
| Black Hills Ammunition | Cover 4 |
| Collector's Armoury | 68 |
| Cor-Bon Bullet Company | 71 |
| Crown Specialty | 67 |
| Danner Shoe MFG | 11 |
| Delta Press | 71 |
| Doubleday Military Book Club | 9 |
| Excalibur Enterprises | 66 |
| Executive Protection | 13 |
| Handstraps | 68 |
| Hikers Hatchet | 15 |
| Intelligence Inc. | 22 |
| JTR Labs | 62 |
| KG Products | 68 |
| Kahles USA | 64 |
| London Bridge Trading CO. | 63 |
| Machine Gun News | 65 |
| Michigan Body Armor | 76 |
| Moore Technical Industries | 12 |
| National ID Center | 21, 69 |
| North American Integrated | 15 |
| Olympic Arms | 65 |
| Optimum Training Systems | 27-30 |
| Orpheus | 70 |
| Paladin Press | 7 |
| Quality Machining Inc. | 64 |
| S & K Products | 15 |
| SOF Convention | 18 |
| SOF Expo | 76 |
| S.T.A.N.O. | 10 |
| Second Amendment Security | 63 |
| The Shotgun News | 20 |
| Sonic Technology | 23 |
| Southern Ordnance | Cover 3 |
| Starlight Imaging Systems | 70 |
| Steve Arnold's Gunroom | 25 |
| U.S. General Technology | Cover 2 |

SUPPLY LOCKER

| | |
|---------------------------------------|----|
| Carl Ax | 72 |
| Cutlery Shoppe | 72 |
| Cutting Edge Enterprise | 75 |
| David Steele Ent. Inc. | 73 |
| Delta Arms | 72 |
| Eden Press | 74 |
| Global Sales | 74 |
| Global School Of Investigation | 75 |
| Gun Parts Corporation | 75 |
| Hitek | 73 |
| Hurricane International | 74 |
| JTR Labs | 75 |
| LA Law Enforcers | 74 |
| LRRP K-9 Services | 72 |
| Miniature Machine Corp. | 75 |
| M.O.R.O. International | 74 |
| Matthews Police Supply | 75 |
| National ID Center | 72 |
| Outback Mercantile | 73 |
| Politically Incorrect Graphics | 73 |
| Professional Career Development | 72 |
| S & K Products | 72 |
| Saddle Up Tee's | 72 |
| Silvermans | 73 |
| U.S. Cavalry | 73 |
| USI Corporation | 74 |
| Westbury Sales Co. | 73 |
| WW2 Products | 74 |

ADVERTISING POLICY: Publication of any advertisement in Soldier Of Fortune Magazine is not an endorsement of the advertiser of the product(s) or service(s) advertised, either by SOF Magazine or by the Editor and Publisher.

CLASSIFIEDS

CURRENT REQUIREMENTS - 2.00 per word per insertion - \$40.00 minimum. All ads **MUST BE PREPAID**. Ad copy must be typed or written clearly with authorizing signature, a telephone number (for our files) and full payment. Advertisers offering information packets for a fee must send sample of packet (packets will not be returned). Name, address and telephone number are to be included in your word count. **EXAMPLE:** P.O. Box 693 = 2 words; 80306 = 1 word. Abbreviations such as DI, SGT, 20mm, U.S. count as one word each. Hyphenated words and telephone numbers are counted as two words. No personal services ads accepted. We reserve the right to refuse, delete or change any copy which we determine to be objectionable. Mail classified ads with payment to **SOLDIER OF FORTUNE**, Classified Dept., P.O. Box 693, Boulder, CO 80306.

NOTICE TO READERS

SOLDIER OF FORTUNE Magazine is a magazine of national and international distribution. There may be products for which sale, possession or interstate transportation may be restricted, prohibited or subject to special licensing requirements in your state. Purchasers should consult the local law enforcement authorities in their area

READERS OF BOTH DISPLAY AND CLASSIFIED ADVERTISING ARE ADVISED THAT SOLDIER OF FORTUNE MAGAZINE DOES NOT VERIFY VALIDITY OF EVERY ADVERTISEMENT AND/OR THE LEGALITY OF EVERY PRODUCT CONTAINED HEREIN. SHOULD ANY READER HAVE A PROBLEM WITH PRODUCTS OR SERVICES OFFERED BY AN ADVERTISER, HE SHOULD SEEK ASSISTANCE FROM HIS NEAREST POSTAL INSPECTOR AND ALSO CONTACT OUR ADVERTISING DEPARTMENT. SOLDIER OF FORTUNE DOES NOT INTEND FOR ANY PRODUCT OR SERVICE ADVERTISED TO BE USED IN ANY ILLEGAL MANNER.

U.S. MILITARY INSIGNIA

1940 through Current

Large Catalog, \$3.00

SAUNDERS

Box 3133 - SF - Naples, FL 33939-3133



U.S. GOVERNMENT AUCTIONS

REAL ESTATE, YACHTS, CARS, TRUCKS, PLANES, BOATS, & MORE FOR ONLY PENNIES ON THE DOLLAR. Auction Departments include: **Customs Service, Drug Raid Seizures, U.S. Marshall's Office, D.E.A., I.R.S., R.I.C.O., Sheriff's Office, and MORE!** Our book is the most comprehensive and easy to use guide currently available. To order **"THE COMPLETE GUIDE TO GOVERNMENT AUCTIONS,"** send a \$20 check or money order to **Federal Information Co.,** Box 21658, Dept. G, Washington, D.C. 20009. **Moneyback guarantee.**

BE A PARALEGAL!

Attorney-instructed home study prepares you for an exciting future in America's hot-test career. **Free booklet: 800-223-4543.**

Name _____ Age _____
Address _____
City _____ State _____ Zip _____

The School of Paralegal Studies, Dept. LH171
8065 Roswell Road, Atlanta, Georgia 30328



TELEPHONE LISTENING DEVICE



Record telephone conversations in your office or home. Connects between any cassette or tape recorder and your telephone line. Starts automatically when phone is answered. Records both sides of conversation. Stops recorder when phone is hung up.

\$19.95 EACH Qty Disc Avail

Super Powerful FM TRANSMITTER

Many times more powerful than other transmitters. Transmits up to 1/4 mile to any FM radio - Easy to Assemble Kit - up to 9V battery (not incl.)
For catalog of Transmitters, Voice Scramblers and other specialty items, enclose \$2.00 to USI Corp

Call 407-725-1000 or send \$19.95 + \$1.00 shipping per item to: USI Corp, P.O. Box SF-2052, Melbourne, FL 32902 COD's OK

UNDERGROUND BOOKS

The Anarchist Cookbook.....\$25
The Outlaw's Bible.....\$15
Personal Defense Weapons...\$10
The Poor Man's James Bond..\$22
Poor Man's James Bond II.....\$24
Shadowing and Surveillance..\$15
Privacy, and How to Get It.....\$18
The Paper Trip I.....\$17
Underground Book Catalog.....\$3
Adults Only! CA Res. Add 7.75%
Free Shipping! Fast Service!
Visa/MC Orders Call 800-635-8883
Customer Service 916-725-0341
FAX Your Order 916-725-8848
Checks & Money Orders Accepted
FS Book Co., P.O. Box 417457
Dept. SF, Sacramento, CA 95841

FREEDOM COUNTRY



20 BIG acres in WESTERN MONTANA, starting at \$9850. Trout fishing, backpacking, camping. Elk, deer, moose, bear. **ADJACENT** to National Forest, near established towns. Yellowstone and Glacier National Parks nearby. **GUARANTEED ACCESS, INSURED TITLE, WARRANTY DEED. FREE** color brochure, photos, maps.

FULL MONEY-BACK GUARANTEE
"Video Available"

CALL TOLL FREE 1-800-592-5990

TREASURE STATE RANCHES
210 Milwaukee Street, Dept. S
Deer Lodge, Montana 59722 - (406) 846-1000

PHOTO ID CARDS

- Drivers Licenses
- Law Enf. Certificates
- Social Security Cards
- College Degrees
- Birth Certificates
- Military Certificates
- High School Diplomas
- Trade School Diplomas

Free Information

Miller Publishing Co., Dept.SOF

7850 White Ln. Ste. E330 BKFD, CA 93309

MEET WOMEN WORLD-WIDE

FREE 32 page photo catalog from America's most respected correspondence service since 1974.

CHERRY BLOSSOMS

190FT Rainbow Ridge

Kapaau, Hawaii 96755

1-408-980-7488



APPAREL

WORLDWIDE MILITARIA & CAMOUFLAGE, New 16 page Catalog of Camouflage & Gear from around the world! Catalog \$1.00. A.H.A., Box 21606, Denver, CO 80221. (201)

FRENCH FOREIGN LEGION TEE SHIRT with Legion Motto in French and Lofini \$10.00 each! WOLFGANG, Box 709H, Prudenville, MI 48651. (201)

D-DAY 50TH ANNIVERSARY Commemorative T-shirt, C.I.B. pocket logo, C-47 with invasion markings, dropping troops. FREE INFO WRITE: PDT, 7301 Burnet, Suite 102221E, Austin, TX 78757. (201)

BOOKS & PUBLICATIONS

MEN OF ACTION AND ADVENTURE - Paladin Press has been described as "the most dangerous press in America." Millions of satisfied readers disagree. Outrageous and controversial books and videos on firearms, exotic weaponry, new identity, creative revenge, espionage and investigation, privacy, action careers, and more! To order our 64-page catalog send \$2.00 to: PALADIN PRESS, Box 1307-4GST, Boulder, CO 80306, (303) 443-7250 (206)

SOLDIER OF FORTUNE Magazine Binder. Holds 12 Issues. \$12.00 plus \$4.00 P&H. VISA/MC accepted. No COD's. SOF BINDER, P.O.Box 693, Boulder, CO 80306. (205)

THE ANARCHIST COOKBOOK is now available again! Complete, uncensored edition. Send \$25 to: BARRICADE BOOKS, PO Box 1401-Z, Secaucus, NJ 07096. (206)

BOOKS ON AFRICAN WARS, hunting, politics. Catalogue \$2 write: Lemur Books, P O Box 1645, Alberton, 1450, SOUTH AFRICA: Fax 011-869-0890 (201)

UNDERGROUND SOURCEBOOK OF RARE DEVICES products and knowledge. The Underground has surfaced! FREE information, write: Box 365-U7, Penfield, NY 14526-0365. (201)

WHO KILLED KENNEDY? Assassination research materials; Videocassettes, photographs, books, unpublished manuscripts. Catalogue: \$3.00. COLLECTOR'S ARCHIVES, Box 2, Beaconsfield, Quebec, H9W 5T6 CANADA. (204)

SIMPLIFIED CHEMISTRY FOR EXPLOSIVES. Simple methods for making C-4, TNT, more. Send \$9.95: ChemEX Development, Box 945, Gadsden, AL 35902. (204)

INTERESTED in a creed of Iron? Read THE ODIN BROTHERHOOD, \$11.50 postpaid from Holmes Publishing Group, P.O.Box 623, Edmonds, WA 98020. Visa/Mastercard telephone/FAX (206) 771-2701. (202)

COVERT ACTION/GEOPOLITICAL STRATEGY. Somalia, Sudan, Iran, Terrorism in Africa. Special Report #11, \$13. STRATEGIC INFORMATION MONITOR, 3250 Olympic Blvd., Box 21, Los Angeles, CA 90404. (201)

MILITARY HISTORY and Technology Publications. For free catalogue write: MILITARY/INFO, Dept. SF, P.O.Box 27640, Golden Valley, MN 55427. (201)

EXOTIC WEAPONRY, Unconventional Warfare. Best books on firearms, military science, martial arts, survival, homesteading. Catalog \$1.00 UNIQUE PUBLICATIONS, P.O.Box 120995, New Brighton, MN 55112. (202)



100% COTTON, BLACK SCREENED T-SHIRT
M, L, XL: \$15.00
XXL, XXXL: \$20.00
 ADD \$3 P&H FOR FIRST SHIRT, \$1 ADD'L BUMPER STICKERS: \$1.00 EACH
VERDAMEN
 P.O. BOX 20360
 NEW YORK, NY 10009
 NY RESIDENTS ADD 8.25% SALES TAX

BETTER TO BE JUDGED BY TWELVE THAN TO BE CARRIED BY SIX

★ STAR LAZER
RUSSIAN WHOLESALE



For all your Russian militaria

Night & Day optics, badges, medals, uniforms and naval antiques

Russian Office:
 Suite 45, #59, 2 Linia Vasilovskiy Octrov, St.Petersburg Russia 199034
 Ph:(011) 7 812 218 4264 Fax:(011) 7 812 218 4264
Speak to Katya
Sales Office:
 P.O.Box 1191 Lane Cove, NSW 2066, Australia
 Ph:(011) 61 2 417 8824 Fax:(011) 61 2 417 8871
Speak to Bal

REGIMENTAL INSIGNIA & WEAPONRY
 • SAS • RAF • BLACK WATCH
 • PARA • AM • CAMERONS
 • ASDG • AN • GUARDS etc.

Import Catalog \$6.00
BRITISH REGALIA IMPORTS
 Department-6
 P.O. Box 50473 • Nashville, TN 37205

Now YOU can join

OPEN TO THE PUBLIC AS WELL AS TO PROFESSIONAL INTELLIGENCE MEMBERSHIP.



Receive membership card, newsletters, important reports, special product offers and some very interesting opportunities.

SEND YOUR \$28. CHECK, FOR ONE (1) YEAR'S MEMBERSHIP, MADE OUT TO OUR PROCESSING AGENT:

AMERICAN COMMUNICATION ARTS
 (DEPT. SFC-2)
 1742 GARNET AVENUE - #144
 SAN DIEGO, CA 92109

PAGER HOLSTER •Fast, Safe, Discreet •Press Button, Case Front Pops Open •Hinges Down Allowing Quick Draw of Gun •Clips to Belt •Fits: Bauer, Davis Derringers (.22, .25, & .32), Baby Browning, 25 Autos, PSP & Iver Johnson, .25, NAA 22 LR 1 1/8" BBL, Freedom Arms 22 LR 1" BBL



SeeR, Inc.
 P.O. Box 20983
 Waco, TX 76792-0983

\$19.95 each plus \$2.00 postage & handling
 TWO for \$34.95 plus p & h

Russian Ladies, truly beautiful, want to meet you!

260 Beautiful, Educated Russian Ladies are sincerely seeking friendship and marriage with American men of all ages.

We have selected these ladies from over 4800 applicants.

FREE Color Photo Brochure

RUSSIAN CONNECTION
 Dept. 100 • P.O. Box 888851 • Atlanta, GA 30356
 (404) 458-0909 (24 hours)
 EXCITING MOSCOW TOURS AVAILABLE



SURVEILLANCE
 & COUNTERSURVEILLANCE Electronic Devices

Bugging/Phone Tapping Detectors • Caller ID • Covert Video • Phone Scramblers • Voice Changers • Shotgun Mics • Vehicle Tracking • Transmitter Kits • Locksmithing • AND MORE!

7 - Hour Telephone Recording System
 Tapes phone calls automatically, \$125.00

EDE FOR CATALOG SEND \$5.00 TO...
 P.O. Box 337, Buffalo, NY 14226 (716) 691-3476

MILITARY VEHICLES

SUBSCRIBE TO THE MAGAZINE THAT MORE THAN 10,000 READERS TURN TO FOR ARTICLES, ADS & NEWS ABOUT MILITARY JEEPS, TRUCKS, TANKS & MORE!



Full listing of upcoming rallies.

SKELETON KEY
FITS MOST LOCKS
 (bollocks, doorlocks, & some padlocks)
 Amaze Your Friends

With A Lock-Picking Demonstration. You get 3 sized metal tension keys, the slide pick, precise instructions & more. Note: this device is to be used for demonstration purposes only! Satisfaction Guaranteed or Full Refund; 2 weeks delivery.

To get this exciting device, Send Now ONLY \$8.95 + \$2 S&H to:
 Safe Marketing • 90 W. Montgomery Av No.3665F • Rockville Md 20850

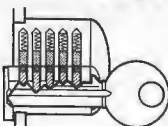

CHOOSE FROM HUNDREDS OF FASCINATING WOMEN

America's only guidebook on meeting international women, *Fantasy Islands: A Man's Guide to Exotic Women and International Travel*, is for the adventurer in search of romance or the man looking for a life-partner from a distant land. How to: ✓ Get 100s of letters...and photos...from exotic women. ✓ Go to nightclubs with 10 women for every man. ✓ Travel alone and never be lonely. ✓ Meet beautiful women from places like the Philippines, Costa Rica, and Australia. Learn why the best way to travel is with a woman in her native land...why international women are crazy about American men...international introduction services. Try finding this information in a library or bookstore! One year guarantee. Send \$29 to World Community Publishing (2), 734D Haight, Alameda, CA 94501. Add \$7 for foreign air.

NEW BOOK on Richard Gatling and Gatling gun featuring 145 photographs (many rare and never before published). **GATLING-A PHOTOGRAPHIC REMEMBRANCE** by E. Frank Stephenson, Jr. \$25 plus \$4 shipping and handling. MEHERRIN RIVER PRESS, 301 East Broad Street, Murfreesboro, NC 27855. (919) 398-3554. Visa/Mastercard accepted. (201)

"DIVORCE: A SURVIVAL GUIDE FOR MEN". Avoid costly mistakes! Read the NEW information packed booklet before SHE does! RUSH \$10.00. Moneyorder, SORRY, NO CHECKS. C&C Publications, Dept.SOF, P.O.Box 354, Nazareth, PA 18064. (201)

ENCYCLOPEDIA OF REVENGE - Now in soft cover! The most devastating manual ever published! Over 1000 entries. Completely cross-referenced. It would take 15 books to equal the information jam-packed in this giant 8 1/2" x 11" volume. \$19.95 plus \$3.50 shipping/handling to: ANCHOR PUBLISHING, P.O.Box 2630-S, Landover Hills, MD 20784. Visa/Mastercard orders call 24 hours. (800) 448-6280. Dealer inquiries invited. (201)

MILITARY VEHICLES
 MAGAZINE

USA: 1 Year (6 Issues) \$15 • 2 Years (12 Issues) \$25
 Canada: 1 Year \$24 • 2 Years \$44. All Others: 1 Year \$26 • 2 Years \$46
 P.O. Box 1748-L • Union, NJ 07083

THE MARKETPLACE FOR MILITARY VEHICLES

SPECIAL FORCES PEAK CONDITIONING MANUAL. Train and look like the men in SF. Includes Diet, PT, Running, and Weightlifting Routine. Get strong and tough! RUSH \$11.95 to THE ELITE, P.O.Box 600130, Lake Hiawatha, NJ 07034. (203)

ROARING CARGO—Politically incorrect slam-poems from a critically acclaimed poet. Buy it before it's banned. Send \$7.00 to WOLF-WISE PRESS, 12235 N. Cave Creek Road, Suite 6, Phoenix, AZ 85022. (201)

BUSINESS OPPORTUNITIES

LET THE GOVERNMENT FINANCE your new or existing small business. Grants/Loans to \$500,000. Free recorded message: (707) 449-8600. (KW5) (202)

COLLECTORS

MILITARY COLLECTIBLES: WWI/WWII/Korea/Vietnam. CURRENT: Patches/Badges/Rank Insignia/etc. Catalog \$3.00. CALL (408) 295-1136 or write: LEE-JACKSON MILITARIA, P.O.Box 8663, San Jose, CA 95155-8663. (201)

BRITISH/SCOTTISH MILITARIA COLLECTORS. Regimental Insignia and accessories of elite Regiments; including SAS; Paratroopers; Royal Marines; Black Watch; Guards, etc. Import Catalog \$6.00. BRITISH REGALIA IMPORTS, Department 6, P.O.Box 50473, Nashville, TN 37205. (201)

VIETNAM WAR INSIGNIA AND UNIFORM LIST. I mail a list of Vietnam War Militaria six times per year. Buyers receive a list free, others pay \$3 per list. Insignia are pictured so you know what you are buying. I always have a nice collection of original patches, insignia, books, maps, uniforms, field gear etc. Both U.S. and VC/NVA. I also buy singles and collections of Vietnam War souvenirs. 100% guarantee from me. Buy with confidence. Write or call. I always enjoy getting the straight skinny from the troops in the field. BILL BROOKS, P.O.Box 230832, Montgomery, AL 36123. 244-1916. (205)

WWII RELICS! Cheaper than certain "well-known" relics dealers! We beat their prices for flags, daggers, medals, helmets. Catalog, \$5 (refundable). Telephone: (612) 689-1146. MILITARIA, Box 261-D, Cambridge, MN 55008. (203)

RHODESIAN AND SOUTH AFRICAN BADGES. Medals and uniforms for sale. For a list send \$1 to KAPLANS, Box 890638, Lyndhurst 2106 South Africa. (201)

SPECIAL FORCES TIGERSTRIPE UNIFORMS, 1968 Vietnam Pattern worn in "The Green Berets" NEW \$72.00, Matching Boonie Hat \$16.00. A.H.A., Box 21606, Denver, CO 80221. MasterCard & VISA Accepted! (201)

WARSAW PACT SCOPE MOUNT, \$25.00, 10 Soviet Badges \$15.00. Check or money order: R. Boynansky, Postfach NR 1425, 64836 Munster, GERMANY. (201)

MILITARY PICTURES. Tanks, Helicopters, etc. 8x10 \$5.00. 16x20 \$11.00. KODAC color paper, negatives printed. For examples send SASE to: MILITARY IMAGES, P.O.Box 6385, Lawton, OK 73506. (201)

UNITED NATIONS BERETS, Sky Blue Beret with Enamelled U.N. Badge Unissued \$30.00. U.N. Patches \$4.50, Identify Cards \$4.50, Observer's Baseball Caps \$20.00. A.H.A., Box 21606, Denver, CO 80221. (201)

NOVELTY MILITARY ITEMS. Pins, patches, flags, uni bumper/window stickers, and more. COLOR Brochure \$2.00 each. D&G, P.O.Box 180, Salem, AL 36874. (201)

EDUCATION

TERMPAPER ASSISTANCE. 19,278 topics available! 306-page catalog—rush \$2.00. Research, 11322 Idaho, #206EX, Los Angeles, CA 90025. TOLL-FREE HOTLINE: 800-351-0222 (California: 310-477-8226). (202)

NUDISM LIFESTYLE: FAMILY RECREATION

Publications • Videos

\$3 for details:

LIFESTYLES-SF

Box 661268, Los Angeles, CA 90066

**Absolutely
FREE!**
3 EXOTIC
VIDEOS!



FREE!
Wholesale to the
public CATALOG
with 3 FREE VIDEOS
Special bonus offer for all new
customers, enclose \$3 shipping.
SPECIAL: 10 VIDEOS \$10
VIDEO PROMOTIONS Dept. 5074
Box 85311, Hollywood, CA 90072

YOUR MILITARY MEDALS!



LARGEST INVENTORY IN THE U.S.A.!

- FULL SIZE US MEDALS
- UN AND RVN MEDALS
- MINIATURE MEDALS
- OFFICIAL RIBBONS
- RANK BADGES, PATCHES... ALL GUARANTEED!
- SKILL BADGES
- DISPLAY CASES
- MANUALS ON CLAIMING MEDALS

SEND \$2.00 TODAY FOR ALL NEW COLOR CATALOG!

MEDALS OF AMERICA
1929S2 FAIRVIEW ROAD
FOUNTAIN INN, S.C. 29644



BEWARE!

The World's Most Powerful Blowguns
are DOWN & DIRTY!

Write or Call For Immediate Info.

J.W. McFARLIN COMPANY

P.O. Box 209, Lake Havasu City, AZ 86405-0209
Tel. (602) 855-8095

EMPLOYMENT

ALASKA OPPORTUNITIES HANDBOOK. Live, work & play in the "Last Frontier". \$10 booklet. Box 302SC, 2900 Boniface, Anchorage, AK 99504. (201)

OVERSEAS, STATESIDE. \$100-\$1,000 dolly. Now hiring. FREE list. ZINCS 117, Box 585, Dearborn, MI 48120 (202)

WORK IN PARADISE: Secrets of Overseas Employment. Tax Free Income. FREE Info: IES, 15327 Sunset Blvd. #106, Pacific Palisades, CA 90272. (202)

ALASKA—WORK WHERE YOU WANT TO PLAY—Job Opportunities Booklet—\$10. Box 302SC, 2900 Boniface, Anchorage, AK 99504. (201)

INTERESTING CAREER LISTINGS: Police, security, investigation. Nationwide, some international. Executives to \$119,300. Passions explained. Four monthly issues. \$21.95. PSIC/FO, P.O. Box 3831, Springfield, IL 62708. (201)

FIREARMS - ACCESSORIES

NATIONAL MILITIA NEEDS YOU! United States Special Field Forces: Government chartered, needs leaders as volunteer officers in home town. Courageous, self-reliant 18 or older. \$5 brings information and application for commission. Write: GENERAL, Box 432, Camp Bradley, FL 32066 (212)

IMPORT/EXPORT. Firearms, parts, related equipment, licensable items our specialty. CIS TECHNOLOGIES, INC., P.O. Box 20943, Atlanta, GA 30320. (204)

FOR SALE

20-40 ACRES—\$5,995 & UP. MONTANA LAND CO., Box 5237, Helena, MT 59604. (406)442-7696. (201)



Red, White & Blue Design
First Amendment Products, Inc.
486 New Park Ave, Dept. SCF-074
West Hartford, CT 06110
Please allow 1-2 weeks for delivery

SUMMER SPECIALS

Heavyweight T-Shirts
Small - XL.....\$12.50
2XL - 3XL.....\$14.30
Buttons & Bumper Stickers
Buttons & 3x4 or 3x7 Bumper Stickers
\$2 for 1 / \$3 for 3 / \$10 for 7
Ceramic Coffee Mugs
\$9.95 for 1 / \$35 for 4
All prices reflect FREE shipping & handling
CT Res. add 6% Sales Tax on Bumper Stickers & Mugs
Check or Money Order / Visa or MC \$10 min.
FREE Catalog with order or Call 203-232-1595



JUSTICE FROM A DISTANCE

T-SHIRT (Black on Gray) \$ 15.95
(Designate Size M L XL XXL)

ARTIST PROOF PRINT (8 1/2" x 11") \$ 25.95
(1 of 250)

ADD \$ 2.50 S&H Idaho Residents ADD 5% Tax

Send Check or Money Order to:

Snow Crest Mountain Enterprises
6799 Panorama Drive, Idaho Falls, ID 83401

Allow 6-8 weeks delivery when using Personal Checks.

IT'S INCREDIBLE how easy the original issue lenses are broken. Simply snap out the old lens. Then snap in place our polycarbonate lens, which is not bullet proof, but thicker and much stronger than the original issue. (250 times stronger than glass of the same thickness). Scratch resistant and U.V. resistant, super hard polycarbonate anti-shatter, anti-scratch lens allows you to snap in your original issue neutral gray lens over our lens for brightness control.

The Sun, Wind and Dust Goggles are issued by the Armed Forces to use under the Kevlar Helmet.

Z-Thru Products™ has formed lenses to fit.

Call for group and quantity discounts. Dealer inquiries welcome.

6314 Greenwood Ave. N. Ste. 4102, Seattle, WA 98103
Pre-Paid. \$30.00 includes shipping & handling.
\$35.00 includes C.O.D.
1 (800) 424-8476

U.S. funds, cash, check, or money order.

ISRAEL MILITARY PRODUCTS



AIRBORNE T-SHIRT S-XXI \$11+\$3 POST
IDF WEBBING, HELMET, INSIGNIAS, UNIFORMS, T-SHIRTS
CATALOG \$2 (FREE WITH T-SHIRT ORDER)
IMP P.O.B. 31006, TEL AVIV 61310, ISRAEL

FREE

FREE CATALOG. Military/Education Diplomas, Certificates, Awards; any High School, University, Government Dept. New European & Corporate Coat of Arms. COUCH POTATO PUBLISHING, 4211 Little Rd., Suite 9, New Port Richey, FL 34655. USA. (201)

DRIVER'S LICENSE (entire USA). Must be U.S. citizen. Free application, information. MAXSELL, Box 23021, Ft. Lauderdale, FL 33307. 305-568-1480 (24 HRS). (202)

INSTRUCTION

SKS FULL AUTO CONVERSION. No modification, alteration or deletion of original parts. Simple illustrated instructions \$10. SARDAUKAR, Box 38531-S, Germantown, TN 38138. All BATF Rules Apply. (204)

INVESTIGATION CAREER. Quick, easy home study. 12 lessons. Become a professional. Free information. SHAW INVESTIGATION, (since 1971). Call (800) 272-6680. (202)

KNIVES - BAYONETS

COLD STEEL, SPYDERCO, GERBER, SOG and more. Huge discount! Free list. KNIVES PLUS, 2467 Interstate 40 West, Amarillo, TX 79109. (806)359-6202. (204)

COMBAT TARGETS

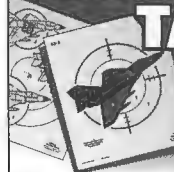

Six original designs
for handgun and rifle.

A new series of targets—

Combines tanks, ships and aircraft with special scoring zones. Printed in USA on regulation target paper. Standard size: 10 1/2 x 12 in. 36 targets for only \$9.95 plus \$2.00 shipping.

★ SEND CHECK OR MONEY ORDER TODAY ★

RATTLER RIDGE 236 West Portal Ave. #324-B
San Francisco, CA 94127

Name _____

Address _____

City _____ State _____ Zip _____

★ SATISFACTION GUARANTEED ★

KNIVES! CROSSBOWS! MARTIAL ARTS WEAPONS! HIGH QUALITY - WHOLESALE PRICES

Send \$6.00 for complete catalog to:
SOUTHERN TRADING COMPANY
P.O. Box 247 • Elkmont, AL 35620

SPECIAL: 60lb pull crossbow pistol \$22.95 Plus \$5.00 shipping.
Survival Skinner-Knife: \$12.95 Plus \$3.00 shipping.
(Life time Guarantee.)

Men & Women! Be A ...

PRIVATE EYE



Amazing one-of-a-kind home study course tells all! Want a life of intrigue, excitement, adventure?! Quickly learn from the experts:

- How To Earn \$100,000 A Year As Your Own Boss!
- How To Conduct All Types Of Private Investigations, Skiptracing & Surveillance!
- How To Start Your Own Private Detective Agency!
- How To Work From Home, Part-Time or FullTime!
- No Experience Necessary, No Investment Required!

STATE APPROVED

Located in the Entertainment Capitol
Of the World! (213) 879-1165

FREE DETAILS **UNITED STATES ACADEMY OF PRIVATE INVESTIGATION**
P.O. BOX 2133 (SF)
BEVERLY HILLS, CA 90213

EZ-OPEN Unique American factory made automatic folders. Satisfaction Guaranteed, Send stamped SASE. EZ-OPEN, 2472 Broadway, Suite 305, Dept SCF, New York, NY 10025. (202)

MISCELLANEOUS

50,000 MAPS. TOPOGRAPHIC. Tactical quads, travel, political (Vietnam, Shikha, Ohio, ANYPLACE). Catalog \$3.00 (refundable). MONARCH, P.O. Box 42003-203F, Phoenix, AZ 85080. (1-602-530-8687 "Beck"). (201)

VANISH FROM POLICE RADAR! FCC legal Jammers reliably defeat police radar & laser speed guns. \$200-\$595. License plate lens beats Photo Radar. Brochures: JAMMERS, 800-451-4477. (201)

NEW IDENTITY! Everything included to completely change identity. Driver's license, Social Security, Birth Certificate, Identification Card, Complete Instruction Booklet. Send \$29.95 to "CAS", P.O. Box 2392, Redondo Beach, CA 90278. (201)

Surveillance Audio Amplifiers

THE CULT OF ELECTRONIC SUPER-HEARING

Why the sudden interest in the Cult of Electronic Super-Hearing? Is it the astounding SoundField™ Microphone? Area scanning with binaural mics? The Zeta Noise Blocker™? Or could it be the wealth of circuits & projects, the undetectable phone bug that runs off line current? Maybe the gizmo that "interrogates" the phone line? It probably isn't getting \$1000 performance on a \$10 budget; certainly not the design one's own amps, filters & equalizers. Whatever it is, the book is still 8.5x11, 264 pages of densely illustrated madness. \$33 domestic postage paid. Registry Distributing, 200 Union Blvd, Suite 430, Lakewood, CO, 80226. Sold only to inform.

Mike Tyson

\$5000 Per Month...

...Deposited in your bank account just for filling out a special form that I will send to you. *Need more money? Just fill out another form. It's that simple!*

Limited time only. Send \$15.00 today.

PROCUREMENT
Box 163933F
Miami, FL 33116

Money Back Guarantee!

Need NEW ID ?
CREDIT • PRIVACY

OUR BOOKS HELP YOU GET: New Identity & credit.

- Jobs in 48 hours. College degrees. ID by mail.
- Cash income. Private loans. Asset protection.
- Offshore banking. Foreign passports & MORE!

FREE 40 pg. **PRIVACY CATALOG**: 800-338-8484
EDEN PRESS • Box 8410-PS • Fountain Valley, CA 92728

THAI ASIAN WORLDWIDE

LADIES 270 Photo Catalog
Beautiful Women Around
The World Seek Loving Men

TAWL Box 937(SOF) Kailua-Kona, Hawaii 96745. FREE Brochure 808/329-5559



EMERGENCY PASSPORTS
TRAVEL INCOGNITO

AFRAID TO TRAVEL AS AN AMERICAN?
NEED ALTERNATE IDENTIFICATION?

FOR TRAVELERS AFRAID OF BEING SINGLED OUT BY TERRORISTS, HIJACKERS OR KIDNAPPERS, WE OFFER PASSPORTS FROM VARIOUS COUNTRIES.

"AN AMERICAN? — NOT ME!"

CUSTOM MADE LEGAL SECOND PASSPORTS WITH YOUR PHOTO AND PERSONAL INFO PLUS TWO BACK-UP I.D. CARDS - \$125.00

SEND \$2 FOR INFO AND BROCHURE

SAFEGUARD SERVICES
P.O. Box 689-F Ely, NV 89301
(702) 289-4229

COLLECTORS & SPORTSMEN

AUTO KNIFE BLOWOUT!

#102 #104

\$39.95 ea.

2 For **\$64.95**

Plus Free Swiss Army Knife

#102 NATO MILITARY
3 1/4" Stainless blade. Front opening, fast lever-action.

#104 THE GODFATHER.
Stiletto. 4" lightning-quick side open stainless steel blade.
Lifetime Money-Back Guarantee.

Order 2 knives & get **FREE!** Swiss Army Knife.

Check or M.O. to **PERFORMANCE KNIVES**
1202 Lexington Ave (Rm 192) Dept A-7, New York 10028
Limited offer. ACT NOW **1-800-324-4371**

Telephone Listening & Recording Devices

MA-100 Devices Hidden In Dual Modular Adapters!
DMR-20 Recording Adapter

Crystal clear reception on FM radio up to 1/4 mile
SnapKit uses phone line for power & antenna

Starts & stops recorder when phone is used.
Plugs into standard cassette recorder
Works when any phone in house is used

\$25.95 free shipping Visa/MC (214) 255-7490 **\$29.95**
Seymour Radix Inc. Box 166055 - SF Irving, TX 75016

BEATING RETREAT (60 Minutes)

VHS ONLY **\$39.95**

By the massed bands of the Royal Marines. A spectacular rousing performance.

BRITISH REGALIA IMPORTS
Department 6
P.O. Box 50473, Nashville, TN 37205

This pen won't write...
BUT IT MAY SAVE YOUR LIFE!!

The Fountain Pen Pepper Sprayer contains Maximum Strength pepper gas — Will stop attackers up to 8 feet away! Have peace of mind for only \$14.95. Free catalog with order.

Send Check/Money Order to:
URBANTECH 405 Tarrytown Rd.
Dept. 771 White Plains, NY 10607

SOLID BRASS PAPER WEIGHTS

Made from 1/2 lb of solid brass. Polished to a smooth finish

\$12.95 Each or 2 for \$22.50

Send check or money order plus \$4.00 Shipping & Handling to:
Bud K World Wide
P.O. Box 565 Dept SF
Moultrie, GA 31776

MC or VISA call **1-800-543-5061**

CUSTOM PATCHES, PINS, DECALS, CAPS

CUSTOM PATCHES PINS DECALS CAPS

HIGHEST QUALITY LOWEST PRICES

FREE CATALOG & SAMPLE

STADRI 71SF Tinker St. Woodstock, NY 12498
914 679 6600 Fax 914 679 6649

Dysfunctional Veteran

leave me alone!

m-l-xl t-shirt \$15.00
xxl-xxxl t-shirt \$20.00

School of Hard Knocks
Box 181-SOF
Cut-N-Shoot TX 77303-0181

School of Hard Knocks catalog \$2.00

FREE VIETNAM FIREBASE/Agent Orange maps Vietnam, Korea. "Storm" maps catalog free! Send SASE. MONARCH, Box 42003-203E, Phoenix, AZ 85080. (1-602-530-8687. "Beck") (201)

LOST DOCUMENTS REPLACED. College Degree, High School Diploma, Birth, Baptismal, Marriage, Divorce, Discharge Etc. SASE to MAXSELL, P.O. Box 23021, Ft. Laud. FL 33307 (203)

BEAUTIFUL RUSSIAN WOMEN! through overseas correspondence eager, sincere and faithful! FREE 32 page - 500 photo catalogue. CLUB PRIMA, 13164 Memorial Drive, #233DD, Houston, Texas 77079. (713) 973-1515 anytime. (203)

BEAUTIFUL, TRADITIONAL, ROMANTIC Asian ladies desire friendship and marriage. Free photo brochure. ASIAN CONNECTIONS, Box 1230, LaGrange, TX 78945. (409) 242-5820. (201)

ADVENTURE IN PARADISE! Beautiful South Pacific Islands can be acquired for as little as \$200.00. For info write or call PACIFIC ISLANDS CONSULTING, P.O. Box 1010, Dept. B, Blue Jay, CA 92317. 1-800-854-0866 (201)

RUSSIAN LADIES, truly beautiful, educated, want to meet YOU. Free color photo brochure. Russia46, P.O.B. 888851, Atlanta, GA 30356, (404) 458-0909. Anytime. (203)

ORIENTAL WOMEN in Asia seek husbands. English speaking. No bargirls. Direct contact. PACIFIC INTRODUCTIONS, 1 Carral Lane SF, Ashland, OR 97520. (201)

YOUR FBI, CIA, IRS RECORDS & MORE! \$49.95 + \$6 shipping plus name, SSN, birthdate & place. BLUETREE, Box 4177VF, Mountaintop, CA 94040. (202)

CRAPS. Amazing method wins consistently. New discovery. First time available. Guaranteed! Free information. D. LESSNAU, 178 Ridgfield, Winchester, TN 37398. (201)

UNIDEN BEARCAT SCANNER, Model 8C800XL, receives police, fire, aircraft, ambulance, race cars, public service, plus cellular phone calls, 40 channel base, also runs on 12 v dc, one year factory warranty, the 8C800XL will not be manufactured in the future due to the federal law banning the manufacture of radio scanners capable of receiving cellular phone frequencies. MasterCard, VISA, COD cash only, \$229.99 plus \$8 shipping each. SCANNER WORLD USA, 10 New Scotland Ave, Albany, NY 12208. Phone (518) 436-9606. (203)

MEET BEAUTIFUL ASIAN COEDS through correspondence. For free photo brochure write to: The Phil-Am Connection, 366 N. Allen Ave., Suite 331, Pasadena, CA 91106. (201)

TV CABLE/SATELLITE ("GRAY" MARKET) descrambler expose. 160pp, illustrated, with vendor lists for chips, parts. Law, countermeasures, much more! \$23.75 + \$3 S&H. Check/MO to INDEX, 3368 Governor Dr., Ste 273-G, San Diego, CA 92122. Credit Cards only: 800-546-6707. Free catalog of "insider" books on scanners, cellular, credit, eavesdropping, much more. (201)

FRIGHTENING, describes our Computer Investigation Service. DANGEROUS, describes our Underground Manuals. FREE Catalog. INFO3, 680 Grapevine Hwy, Hurst, TX 76054. (205)

BIRTH CERTIFICATES (any state). For brochure, please send self addressed stamped envelope to: (SGJ), P.O.Box 22461, Tucson, AZ 85734. (201)

LIVE 24 HOURS/DAY!! Talk to beautiful girls! 1-900-407-2273 Ext 8705. \$3.99 per minute. Must be 18 yrs Procall. (201)

PHOTO I.D. CARD (50 states). Send photo, eye/hair color, height, weight, birthdate. \$15.00 MAXSELL, P.O. Box 23021, Ft. Lauderdale, FL 33307. (203)

MALE POWER PACK. Creates/builds muscle, strength, stamina, endurance. Can elevate testosterone level 200%! Enhances virility. Safe. ON SALE: 1-800-878-8844. (201)

BEAUTIFUL MEXICAN WOMEN seek romance! Free photos, full information. LATINIS, Box 1716(TN), Chula Vista, CA 91912. (619) 685-5195. (201)

ASIAN WOMEN DESIRE CORRESPONDENCE! Overseas, sincere, attractive, traditional. Free details! SUNSHINE INTERNATIONAL CORRESPONDENCE, Box 5500-ZH, Kailua-Kona, Hawaii 96745 (808) 325-7707 (204)

R & R FOR SINGLE MEN. Dream vacation with beautiful, playful Filipinas, as featured on "Inside Edition". BIG APPLE ORIENTAL TOURS (SOF), 24912 Elkmont Ave., Bellerose, NY 11426 (201)

NIGHT VISION EQUIPMENT

DON'T BUY NIGHT VISION until you see the most comprehensive catalog of NVD's available! Includes educational reports, discounted prices on ALL major AMERICAN manufacturers, RUSSIAN importers, and MORE! We carry all NVD products we can find! The new BOEKE NIGHT VISION SUPPLY. 1-(800) 55-BOEKE for free introductory catalog, or send \$9.95 to receive comprehensive catalog and membership discounts. 407 Melbourne, Columbia, MO 65201. (201)

REMAILING SERVICES

CONFIDENTIAL ADDRESS. Mail received here, then forwarded to you worldwide. Valcemail, total MAILPOST, 2421SOF Prati, Chicago, IL 60645 (312) 764-0100, (800) 890-3199. (201)

NOTICE TO SUBSCRIBERS

From time to time, we make our list of customers' names and addresses available to carefully screened companies to send announcements of their products or services.

If you prefer not to receive such mailings, and want your name on our subscriber list only, please write us, enclosing your mailing label.

Please address your request to:

SOLDIER OF FORTUNE
P.O. Box 348
Mt. Morris, IL 61054
Attn: Customer Service

GORGEOUS ASIAN WOMEN

DESIRE PENPALS,
ROMANCE, MARRIAGE!

Details, color photos — \$1:
P.I.C., P.O. Box 461873-SF,
Los Angeles, CA 90046



U.S. GOVERNMENT LAND

Federally owned land currently available in AK, AZ, AR, CA, CO, ID, MT, NV, NM, OR, UT, WA, WY for **\$2.50 per acre**. U.S. citizens entitled to purchase **up to 160 acres per person**. For complete information package including maps, telephone helpline, filing forms, etc. send \$20 check or money order to: **FEDERAL LAND CO., Dept. L, Box 21598, Washington, DC 20009**. (Note: this is not homesteading—lands are sold outright.) **MONEYBACK GUARANTEE!**

SECURITY PRODUCTS

CONFIDENTIAL Catalog of Police and Investigation Equipment \$2. IPEC, Department SF394, P.O.Box 7638, Moreno, CA 92552. (203)

DOPPLAR RADAR RATIC mobile ANTPS-58A IIT Surveillance detection of vehicles, personnel, helicopters, light aircraft 20KM automatic tracking all weather. Lead lined housing training available. Details write P.O.Box 2382, Nevada City, CA 95959. Mucho Dinero. (202)

COMPLETE CATALOG of personal defense products from STUN GUNS to VIDEOS at wholesale prices. Send \$3.00 to Tombstone Productions, 52 Taylor Street, Holyoke, MA 01040. (201)

SURPLUS

MILITARY CLOTHING, GEAR, BOOTS, JACKETS, Collectibles, etc. Call (408) 295-1136 for FREE catalog or write: LEE-JACKSON MILITARIA, P.O.Box 8663, San Jose, CA 95155. Foreign catalogs ore \$3.00. (201)

MILITARY SURPLUS & SURVIVAL ITEMS; Large inventory, new a used. Mail \$1. (refundable) for price list: HUGH WADE'S, 2120 West Reelfoot Ave., Union City, TN 38261-9732. (202)

MILITARY SURPLUS. New and used, also survival items. Send \$2 for catalog. REMA MILITARY SURPLUS, P.O.Box 7039, Canton, OH 44705. (201)

INTERNATIONAL MILITARIA & CAMOUFLAGE. From 40 Countries! 1994 Catalog \$1.00. A.H.A., Box 21606, Denver, CO 80221. (201)

BDU'S (NEW) 17 different colors, pants: XS-XL=\$24.75, XXL=\$27.00, XXXL=\$28.00. For list of colors and other items send SASE: RJ ENTERPRISES, 6061 CR 500, Ripley, MS 38663. (201)

SURVIVAL

SMOKE BALLS, CARTRIDGES, Candles, Bombs, Pots, Grenades. Largest selection anywhere. Write for 56-page catalogue of 500 products. U.S.-\$3.00, Canada-\$5.00, Others-\$10.00. SIGNUS, Box 33712-W53, Phoenix, AZ 85067 (201)

BUSHPILOT WINGS
BADGE QUALITY — CORROSION FREE RHODIUM
SEND \$8.95 TO: BUSHPILOT
P.O. BOX 541384
DALLAS, TX 75354-1384
CATALOG WITH PURCHASE — ALLOW 4-6 WEEKS

NEWMAN'S GIL SUPPLY 201-848-8260
Rt. 10 Box 10419 Dept. SOF
NEWTON, N.J. 07860

JUNGLE HAMMOCK
\$39

WE PAY ALL SHIPPING & POSTAGE
Send \$3.00 For 200 Item Catalog!

We have not seen a hammock of this good quality in a long time. This Hammock is a copy of the Hammock used in WWII and Vietnam. It is a combination insect proof hammock or stake it as a tent. Full length canopy keeps you dry and the nylon netting keeps those flying and crawling insects off of you.

Cashiers check, money order, personal checks or Visa & Master Card gladly accepted NO COD'S. All merchandise is 100% guaranteed Residents of Alaska, Hawaii and Puerto Rico add 5% for shipping

HAT PINS - PATCHES - FLAGS
1500+ MILITARY DESIGNS
FREE 24 PGE ILLUS. CATALOG
WE DO CUSTOM WORK
Dealer Inquires Welcome

HOOVER'S MFG. CO.
40155F PROGRESS BLVD.
PERU, IL 61354
(815) 223-1159, Ask For David

FREE FULL YEAR SUBSCRIPTION...

Sam Andy SURVIVAL TIMES NEWSLETTER & CATALOG

BE PREPARED! HELPFUL TIPS & PRODUCT FACTS HELP YOU FACE THE FUTURE WITH CONFIDENCE — NO MATTER WHAT! YOU OWE IT TO YOUR FAMILY TO HAVE THIS INFORMATION — FOR YOUR FREE 1 YEAR SUBSCRIPTION — SEND YOUR NAME, ADDRESS & PHONE — Sam Andy SURVIVAL TIMES NEWSLETTER, DEPT. P.O. Box 141741, IRVING, TEXAS 75014 FAX #: 214-269-2097 DEPT. JAD

THE HIVE: BURIAL STORAGE SHELTERS. Hide It. Store It. Save yourself under \$2000.00. Light rugged guaranteed to last. Heavy polyethylene design, large extended concealable access, sealed entrance 8x8x7'6" extendable. Ventilation, power, shelving not included. For brochure write: THE HIVE, P.O.Box 2382, Nevada City, CA 95959. Fax 916-477-5249. (202)

TRAINING

BOUNTY HUNTER TRAINING by professionals; on-site in Florida or at country-wide seminars. Details. NABEA, P.O.Box 6757, West Palm Beach, FL 33405. Phone: (407) 547-3630. (201)

RANGER, AIRBORNE, Bodyguard Training. Catalog and information \$7.00 (\$12.00 Foreign). USTC, 2024 N. Broadway, Suite 205, Santa Ana, CA 92706-2623. (714) 547-2567. (206)

NAVY SEAL FITNESS PROGRAM. Gain strength and self-confidence. Get in shape using the methods of the world's most elite combat unit. Send \$10.95 to: T-N-S ENT, P.O.Box 16297, Seattle, WA 98116. (202)

ELITE COMBAT TRAINING. Small Unit Operations. Long Range Marksmanship Course. Catalog \$4.00. NORTHEAST ENTERPRISES, 1280-A Belmont St., Suite #251, Brockton, MA 02401. (202).

VIDEOS

YOUNG VOLUPTUOUS NUDE Models. Videos from Russia, Asia, Latin America, Europe, Scandinavia, Arabia!!! "Cherry Girl Series". Sample \$19.95. 37 Country PhotoLog \$1.00. TLC, Box 330, Deerfield Beach, FL 33443-0330. (203)

SEXY ORIENTAL BABES want older men for romance and marriage. 250 girl video \$16.95. Photocatalog \$2. VOYAGE, 41 Sutter, #1309-R, San Francisco, CA 94104. (201)

Street Lethal SPEED KILL

Can you hit a man 11 times or more in one second or less?
Can you drop a man to his knees with one blow?
Can you win a fight in 3 seconds or less?

WE TRAIN PEOPLE WHO CAN! FREE DETAILS
Warrior Publications
6252 Dark Hollow Rd., Medford, OR 97501 (503) 535-3188
CUT OUT AND MAIL THIS AD TODAY!

World's Most Fascinating Police Catalog!

112 pg. Catalog
Badges; ID Cards;
Books; Clothing;
Ammo; Weapons;
Spy Equip; Posters;
Hats & more!
World's Best Catalog!

Send \$3.00 for Catalog, or Call 1-900-226-2444 for RUSH shipment! FREE \$3.00 Coupon included with each catalog!

NIC, inc. Box 5950-FC; S.por, LA 71135; (318) 688-1365

ARREST Violators! **Wear the Badge of a DETECTIVE**

TRAIN FAST AT HOME!
BE YOUR OWN BOSS!
NO PREVIOUS TRAINING NEEDED

Your spirit of adventure, danger, and self reliance can lead you to an exciting career opportunity. Solve mysteries, bring criminals to justice, protect the innocent. Experts guide you every step of the way. Men and women needed to work in challenging situations, withstanding hardships, make on the spot decisions. Learn the latest investigative techniques using special law enforcement equipment . . . the same equipment used by the FBI, the CIA, and the Secret Service. Start your own investigative agency. Save up to 25% and more on all equipment. Send for free details.

Approved by Calif. Dept. of Public Instruct.
THE ROUSE SCHOOL of Special Detective Training
Dept. SG407 P.O. Box 25750, Santa Ana CA 92799

Name _____ Age _____
Address _____
City/State/Zip _____

UNUSUAL BOOKS
MANY AVAILABLE NOWHERE ELSE
100's of Titles to Choose!

CREDIT • EMPLOYMENT • EXOTIC WEAPONRY • MARTIAL ARTS • PRIVACY • NEW IDENTITY • DISGUISES • SURVEILLANCE • FIREWORKS and Much, Much More!
Best Prices and Selection. Money Back Guarantee.
Catalog . . . \$1.00

ALPHA PUBLICATIONS
PO Box 308-M Sharon Center, OH 44274

CANADIAN VIETNAM VETERANS QUEBEC MEMORIAL NEEDS YOUR SUPPORT

T-shirts (black or blue) \$18.50
Sweatshirts (black or blue) \$27.00
Patches (Vet or supporter) \$5.50-Pins \$6.00 (all pzd)

Address your donations to the CVVV and your orders to: ROVEND, 5740 Coolbrook Avenue Montreal, Quebec, Canada H3X-2M1

SUPPRESSED VIDEOS - FREE CATALOG. Political, survival, cover-ups, NWO, patriots, etc. 200 titles. UNDERGROUND, P.O.Box 339, Adrian, MI 49221. (517) 263-1078. (201)

RED CELL-ROGUE WARRIOR VIDEO \$14.95. Morcino leads SEALS against U.S. targets. Air Force One! USS Kittyhawk! Actual classified footage. Heads rolled. Judge yourself! (800-782-8892. (201)

WANTED

PROFESSIONAL BODYGUARDS & INVESTIGATORS! If you feel you have the potential to earn \$80 per hour. If you are professional and can assimilate confidential information. ACT NOW! Send \$10 for full information package to B.A.S.E.C., P.O.Box 147, Conventlon Station, NJ 07961-0147. (204)

BUYING WRISTWATCHES: Rolex, Patek, Vacheron, Corlier, Ebel, Breguet, Gubelin, LeCoultre, others. Agents in 30 cities. 1-800-833-3159. DON MEYER, 12900 Preston #500, Dallas, TX 75230. (202).

PARTING SHOT

by Alfred Grey

Fields of Normandy

It was sundown at Colleville-sur-Mer in Normandy. The wind was blowing directly in from the sea. I stood there at attention with my wife and grandson as "Taps" sounded over more than 9,000 graves of fellow Americans, soldiers, who had lost their lives in June 1944.

It was about a year ago when we decided to celebrate our 50th wedding anniversary in France, accompanied by our grandson who had just completed his first year at Ohio State University.

We also reasoned that we would beat what certainly is going to be the second great invasion of Normandy in the spring of 1994. Two anniversaries — and my grandson Greg would have the opportunity to see where history was made.

We trekked the sands of Omaha Beach together. Then, a little way farther up the coast, we walked along the area that I had known quite intimately as Utah Beach.

The infamous hedgerows of Normandy were still in place. But instead of the dust and overcast skies that I recalled — along with the whining shells, the clatter of guns — all was now quiet. The sun was shining, and there were live, fat, brown and white cows and chestnut horses grazing in lush, green fields.

I took Greg over to the steep cliffs of Pointe du Hoc. As he peered down those sheer walls, he marveled in amazement. "How did the 2nd Ranger Battalion scale that insurmountable obstacle in the face of heavy fire?" he asked. "Sheer determination. Doing what had to be done," I told him.

"An absolute miracle."

We walked past some of the remaining battlements that had been left behind, overlooking the sea. There were concrete bunkers, trenches and pill-boxes, along with remnants of artillery pieces, skeletons of tanks and half-tracks. Relics half a century old.

The waves just kept rolling in, as they always seemed to do on Omaha Beach.

Greg was astonished as I attempted to picture for him the terrible odds faced by the 1st Division as they scrambled across the open area of what had been Omaha Beach, almost half the length of a football field of nothing but sand, under terrible machine gun and mortar fire. That's what they had to do if they survived the sea.

U.S. Military Cemetery in La Cambe, Normandy, France as it looked in early spring 1946. Photo: AP/Wide World



We left Omaha Beach to visit the World War II museum at Arromanches. Then we drove inland several kilometers to Ste. Mere Eglise, where my team had camped for two weeks while awaiting orders.

Before driving up the coast, with its memories of the 4th and 29th Divisions, westward past Valognes to Cherbourg, passing the new and strange sights of McDonald's, pizza parlors and French fast food places, we had to visit the cemetery and pay our respects to those who had fallen.

Then too, I wanted Greg to see the contrast: the German cemetery at La Cambe, with its 21,000 dead, buried in little untended mounds, two to a marker, and only a handful of cars in the parking lot.

At the American cemetery, the parking plazas were overflowing. The grass was emerald green. Maps and directions were explicit. Every soldier was identified.

Greg sought out the custodian of the American cemetery, who explained that the scene was not at all unusual. "Every day there are many visitors. Every evening at twilight," he said, "there is always a crowd of people waiting to pay their respects."

The three of us bowed our heads: the veteran; his wife, who had been a young girl when they had married 50 years before; and the 19-year-old young man, who had been born almost 30 years after that "longest day," and who was now the age of some of those young men who had given their lives for their country.

We stood in silence and remembrance.

The wind blew in from the sea and carried the sound of "Taps" inland, throughout the fields of Normandy.

— Now retired, Al Grey is a veteran of Operation Overlord. ✕

VenomTM



THE MOST POWERFUL...THE MOST POTENT...THE MOST EFFECTIVE DEFENSE SPRAY AVAILABLE!!! We're serious about your safety, and nowhere is that more evident than in our line of Chemical Defense Spray VENOM. VENOM was developed to provide you with the highest degree of non-lethal protection available. VENOM is formulated to give optimum performance from each size unit. VENOM is fast acting and hard hitting, and is effective against even drunks, drug abusers, and psychotics.

- 3 Ounce Home/Auto Unit (Maxi-Blast top).....\$24.95
- 3/4 Ounce Pocket/Purse Unit.....\$11.95
- 3/4 Ounce Keyring Unit.....\$15.95
(PLUS \$3.50 Shipping)

THE WORLDS FINEST SLIM JIM

Our premium quality car jimmy tool is made of high quality spring steel, with rounded edges and textured black rubber handle. Comes with instructions.

SJ100.....\$9.95
(PLUS \$3.50 Shipping)

COBRA III+ ELECTRONIC LOCK PICK

"OPENS 99% OF ALL PIN TUMBLER LOCKS IN 7 SECONDS OR LESS"

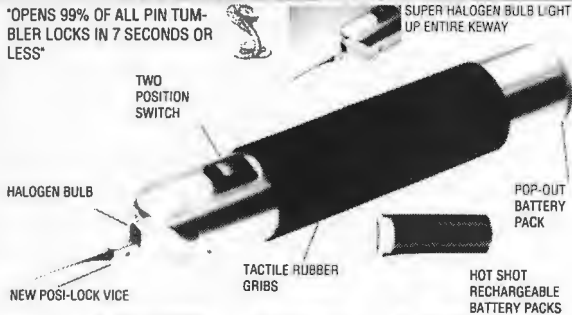

It's a technological dream come true! Finally, there's a fast way to pick open 99% of all pin tumbler locks in use today. All components are manufactured from aerospace aluminum alloys for a lifetime of quality, hassle-free service. The new Cobra III+ is jam-packed with all new features. Our exclusive high-intensity focused halogen key way light source; new tactile rubber grip; extra rechargeable "Hot Packs". The Cobra III+ is shipped complete with rechargeable Hot Pack wall charger, extra picks, tension tools, allen wrench, and shipping case.

Cobra III+.....\$399.00
Comes complete in die cut shipping case (PLUS \$10.00 Shipping)

D100 SAP GLOVES



Made of soft, pliable deerskin, these gloves have 6 ounces of powdered lead inserted across the knuckles of each fist. Discreetly effective.

- D100.....\$69.95
- D-50 (Cowhide).....\$37.95
(PLUS \$4.50 Shipping)

LEATHER SLAPPER



The highest quality slappers available. Constructed of smooth top grain cowhide with a leaded striking end. Available with or without a wrist loop. Made in U.S.A.
BBL20.....\$19.95
BBL21 (With wrist loop).....\$19.95
(PLUS \$3.50 Shipping)

POCKET PROTECTOR

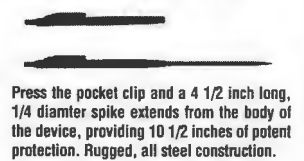

Press the pocket clip and a 4 1/2 inch long, 1/4 diameter spike extends from the body of the device, providing 10 1/2 inches of potent protection. Rugged, all steel construction.

GFR.....\$55.00
(PLUS \$4.50 Shipping)

BRASS KNUCKS PAPERWEIGHT

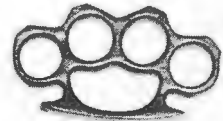

The finest product of its kind available—add a beautiful example of the metal worker's art to your collection.

- KNB.....\$13.50 ea
\$24.50 pr
KNA Lightweight Aluminum
- KNA.....\$8.00 ea
(PLUS \$3.50 Shipping)

Z-FORCE STUN GUNS



Z-FORCE stun devices are the best we've found! They offer reliability, high sustained voltage output and concealability - these devices are compact and powerful.

- ZF-3, 100,000 Volts.....\$44.95
- ZF-4, 120,000 Volts.....\$69.95
- ZF-Ultra, 150,000 Volts.....\$99.95
- SouthOrd Security +, 200,000 Volts.....\$119.95
(PLUS \$5.50 Shipping)

"ACE PICK" TUBULAR LOCK PICK



Opens vending machines, T-top locks, washing machines, etc. This precision tool is made of HIGH QUALITY, HEAT TREATED STEEL, and picks tubular locks with mushroom pins. Includes a decoder and is available for center or offset locks.

- APC 7 (7-PIN).....\$89.95
- APC 8 (8-PIN).....\$89.95
- BOTH PICKS.....\$159.95
(PLUS \$5.50 Shipping)



BLACKJACK

These law enforcement weapons, once the standard of police officers throughout the country, are finely crafted from lead, steel spring, and leather. Eight ounces of nostalgic protection. Made in U.S.A.

BJK8.....\$19.95
(PLUS \$3.50 Shipping)

PXS 14 LOCKPICK SET



This 14 piece set includes everything you need to open most locks and doors—an assortment of picks and rakes, two tension wrenches, a broken key extractor, and cowhide pocket case. Includes the book, Easy Pickins.

PXS14.....\$32.95
PXS17.....\$49.95
(PLUS \$3.50 Shipping)

For our Florida customers, and our friends in law enforcement and military - write or call for a listing of our automatic collector's knives.



CLASSIC ITALIAN



INTERNATIONAL COMBAT SWITCH



THE SPIKE



Navy Seals II



MAXIMUM SHIPPING CHARGE PER ORDER - \$10.00
CHECK, MONEY ORDER, VISA, OR MASTERCARD
Full Line Catalog \$2.00



WARNING: Check State & Local laws regarding use & lawful possession of items above. Must be 18 years or older to order.

SOUTHERN ORDNANCE

"The hardest hitting products in the personal defense industry"

P.O. BOX 279 • DEPT. SF • Babson Park, Florida 33827

FAX (813) 638-2486 • (813) 638-2499



NO POSTAGE
NECESSARY
IF MAILED
IN THE
UNITED STATES

BUSINESS REPLY MAIL

FIRST CLASS MAIL

PERMIT NO. 8

MT. MORRIS, IL

POSTAGE WILL BE PAID BY ADDRESSEE

**SOLDIER OF
FORTUNE**

PO BOX 348

MT MORRIS IL 61054-9817



WHEN THERE'S NO ROOM FOR ERROR...

Negotiations have failed. He will kill her unless you can stop him. No chance for the entry team. Your sniper team is in place. They are good and they are well equipped. They have Leica laser rangefinding binoculars, so they have eliminated the most common cause of a missed sniper shot: range estimation error. In a situation like this, you don't estimate. You rely on dedicated people, extensive training and good equipment. Your team won't fail, because they are prepared.

Leica rangefinding binoculars from Black Hills Ammunition are an indispensable piece of equipment for any Special Response Team. They are compact, reliable, and rugged. They tell you immediately the exact distance to any point 25 to 1000 meters away. They enhance your professionalism and expand your capabilities. Whether you are faced with a hostage situation, planning for a drug raid, doing site surveys, or simply training your team, Leica rangefinding binoculars make your job easier. They reduce your liability by reducing the variables in the situation. They provide the answers you need to make your decisions. They allow you to document vital distances... ahead of time rather than after the situation is over.

13



SPECIFICATIONS

Magnification 7 x 42
Measuring Range 25-1,000 meters
Accuracy within 1 meter
Weight 3-1/2 lbs.
Built-in electronic compass
with LED readout
Price: \$4,495



For information, contact:

Ammunition

Black Hills Ammunition
PO Box 3090 • Rapid City, SD 57709
(605) 348-5150 • FAX (605) 348-9827